

LAB & INDUSTRY EQUIPMENT

BUCH  HOLM



Buch & Holm A/S

Marielundvej 39 • 2730 Herlev • Tlf. +45 44 54 00 00 • e-mail b-h@buch-holm.dk • www.buch-holm.dk
Box 10058 • S-200 43 Malmö • Tel. +46 (0)40 30 50 30 • e-mail b-h@buch-holm.se • www.buch-holm.se

FX-i *FX-iWP* Series



A&D ...Clearly a Better Value
A&D Company, Limited
<http://www.aandd.jp>

Realizing Compact, Increasing Functions!

We have developed a Miniaturized SHS* (Super Hybrid Sensor) to achieve a highly compact precision balance, which is 40% lighter and 47% smaller than our GF series with a 25% smaller footprint, while maintaining A&D's superior weighing functions. *Patent Pending



FX-120i
122gx1mg

FX-200i
220gx1mg

FX-300i
320gx1mg

FX-1200i
1220gx10mg

FX-2000i
2200gx10mg

FX-3000i
3200gx10mg

FX-i



Response Indicator Function

Selectable FAST, MID or SLOW response to suit weighing environment conditions

Comparator Function

Easy to compare weighing results by setting HI limit and LO limit to display HI,OK,LO indicator

ACAI – Automatic Counting Accuracy Improvement

This counting function recalculates the average unit weight each time a sample is added to eliminate errors caused by variations in unit weight

Percent Mode Function

A sample can be registered as 100% and the weight of another sample can be compared as a percentage

B5 Size Footprint

Ideal for installation and use in narrow spaces

Compact SHS–1 Second Stabilization

Quick stabilization speed with accurate weighing for better productivity

Shock Absorber Function*

The internal shock absorber protects the SHS from the adverse effects of vertical or transverse overloading. *Patent Pending

Quick USB Interface (FXi-02)

Easy-to-use optional USB interface, **with no driver installation necessary**, for transfer of weighing data to a computer (applicable OS – Windows 98 OSR2 or later)

SCF–Statistical Calculation Function

Can display and/or output statistical calculation data as No. (number of data), SUM (total), MAX (maximum), MIN (minimum), R [range (maximum – minimum)], AVE (average), SD (standard deviation) and CV (coefficient of variation)

LAN–Ethernet Interface (FXi-08) with WinCT-Plus Software

WinCT-Plus software makes it possible for the user to easily set up an IP address, subnet mask etc. The user can also send commands for control and acquisition of data from multiple FX-i balances.

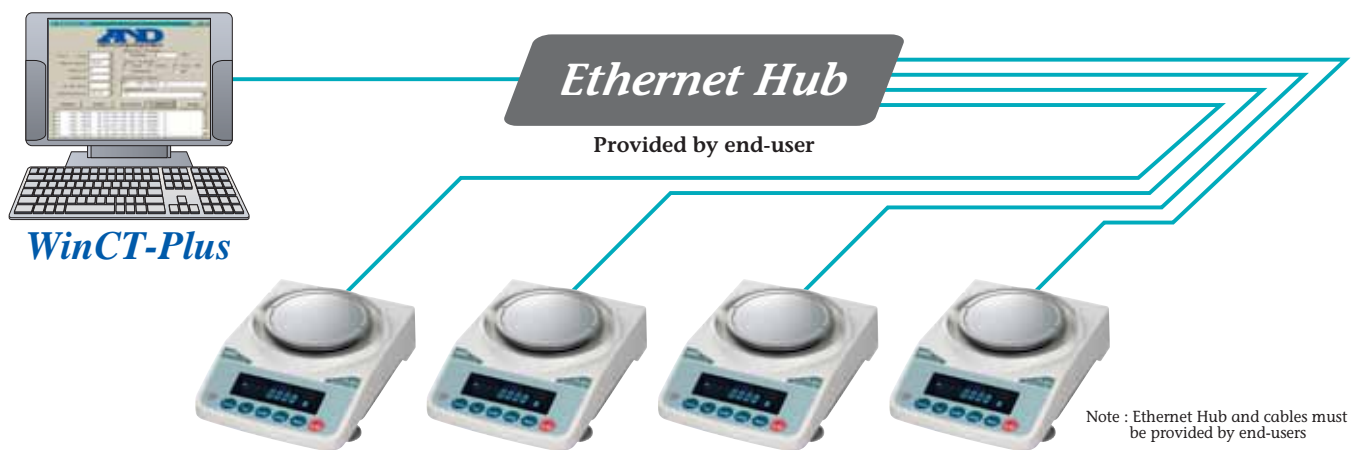

Animal Weighing Function

The HOLD function enables freezing of weighing data for animal weighing applications and an ANIMAL indicator appears on the display

Standard RS-232C Interface

Incorporates bi-directional communication with a PC, printer or other peripheral devices

Underhook

The underhook, for hanging applications, allows for measurement of magnetic materials and density measurements in air and water

Multiple Weighing Units of Measurement

Programmable or standard weighing units of measurement can be selected; g, pcs, %, oz, lb, L oz, ozt, ct, mom, dwt, GN, tl, tol, mes and MLT

The World's First IP65 Compliant, Water / Dust Proof Precision (1mg) Balance!

Yet another breakthrough from A&D enabling the measurement of liquid or powder at 1mg resolution, eliminating any worries about damage to the balance



FX-120iWP
122gx1mg

FX-200iWP
220gx1mg

FX-300iWP
320gx1mg

FX-1200iWP
1220gx10mg

FX-2000iWP
2200gx10mg

FX-3000iWP
3200gx10mg

FX-iWP

SHS
Super Hybrid Sensor

888
VFD Display

44A
Anti-static Counting
Memory Approximation

GLP

RS-232C

FDC
Full Digital Calibration

COMPARATOR

ON

OFF

Buzzer Function

ID

LAN

ANIMAL

USB

under hook

SCF

IP65
Standard Calibration Function

GLP/GMP/GCP/ISO Compliant

In accordance with GLP and LIMS regulations, the balance ID number and calibration data can be printed out using A&D's AD-8121B or a PC

Auto Power ON Function

The weighing mode display activates automatically with AC power so there is no need to press the ON/OFF key

Auto Power OFF Function

The display switches OFF automatically when the balance is inactive for 10 minutes as a power-saving tool

Built-in Rechargeable Battery (FXi-09)*

An optional Ni-MH rechargeable battery pack can be fitted into the FX-i series for use without AC power and for mobile applications (10 hours charging time for 8 hours operation)

* Not IP65 compliant when used with FX-iWP



IP65 means that this kind of measurement is possible.



Highly Visible Display



Firmly Sealed Pan Support



Water Proof RS-232C Cable (optional)



Large Breeze Break (optional)

The small breeze break comes as standard with the FX-120i(WP), FX-200i(WP) and FX-300i(WP), which are all 1mg resolution models.

Specifications

	FX-120i FX-120iWP	FX-200i FX-200iWP	FX-300i FX-300iWP	FX-1200i FX-1200iWP	FX-2000i FX-2000iWP	FX-3000i FX-3000iWP
Weighing capacity	122g	220g	320g	1220g	2200g	3200g
Minimum weighing value	0.001g				0.01g	
Counting mode	Minimum unit mass		0.001g		0.01g	
	Number of samples		5, 10, 25, 50 or 100 pieces			
Percent mode	Minimum 100% reference mass		0.001g		1.00g	
	Minimum 100% display		0.01%, 0.1%, 1% (depends on the reference mass stored)			
Repeatability (Standard Deviation)	0.001g				0.01g	
Linearity	±0.002g				±0.02g	
Stabilization time (typically set at FAST)	Approx. 1 second					
Sensitivity drift (10°C to 30°C)	±2ppm / °C					
Operating temperature	5°C to 40°C (41°F to 104°F), 85%RH or less (no condensation)					
Display type	Vacuum Fluorescent Display (VFD)					
Display refresh rate	5 times /second, 10 times /second or 20 times /second					
Standard serial interface	RS-232C Interface					
Weighing pan (diameter)	130mm			150mm		
External calibration mass	100g 50g	200g 100g	300g 200g 100g	1000g 500g	2000g 1000g	3000g 2000g 1000g
AC adaptor	Confirm that the adaptor type is correct for the local voltage and power receptacle					
Power consumption	Approx. 11VA (supplied to the AC adaptor)					
External dimensions	193 (W) X 262.5 (D) X 85.5 (H) mm					
Net weight	FX-i Approx. 2.5kg / FX-iWP Approx. 2.7kg					

Options

- FXi-02*** Quick USB interface with cable
- FXi-08*** Ethernet interface with WinCT-Plus software
- FXi-09*** Built-in rechargeable battery
- FXi-10** Small breeze break
- FXi-11** Large breeze break
- FXi-WP-10** Small breeze break (gray)
- FXi-WP-11** Large breeze break (gray)
- FXi-12** Animal weighing pan
- FXi-15** Carrying case

* FXi-02, FXi-08 and FXi-09 cannot be used at the same time.
(Not IP65 compliant when used with FX-iWP)

Accessories

- AD-1683** Static eliminator
- AD-8920*** Remote display
- AD-8922*** Remote controller
- AD-8121B*** Compact printer
- AD-8526*** RS/Ethernet converter
- AX-CARATPAN** Carat pan
- AX-KO2737-500-EX** Waterproof RS-232C cable (5m)

* (Not IP65 compliant when used with FX-iWP)



AD-8121B

External Dimensions (mm/inches)

Pan size	A
FX-120i(WP) / 200i(WP) / 300i(WP)	130 / 5.12
FX-1200i(WP) / 2000i(WP) / 3000i(WP)	150 / 5.91

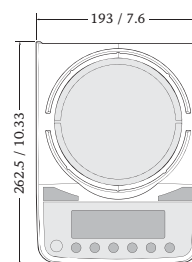
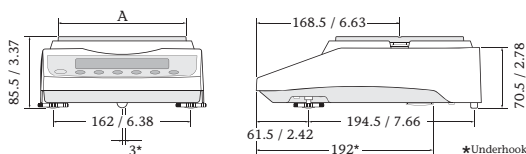

Dimensions with Small Breeze Break (FXi-10/FXi-WP-10)

(Comes equipped with FX-120i(WP)/200i(WP)/300i(WP))

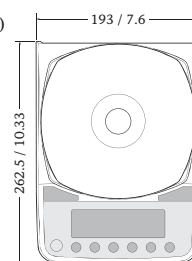
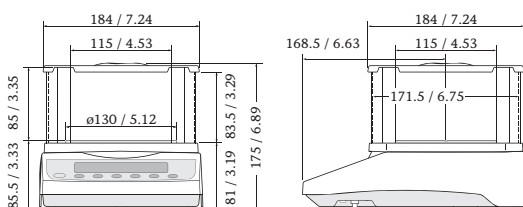

Dimensions with Large Breeze Break (FXi-11/FXi-WP-11)

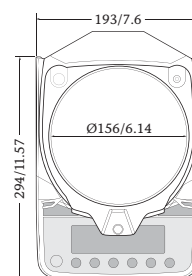
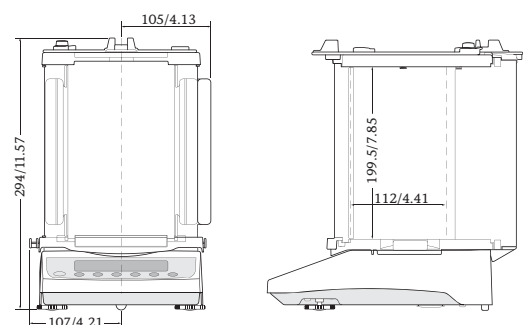

AND

...Clearly a Better Value

A&D Company, Limited

3-23-14 Higashi-Ikebukuro, Toshima-ku, Tokyo 170-0013 JAPAN
Telephone:[81](3) 5391-6132 Fax:[81](3) 5391-6148
http://www.aandd.jp

A&D ENGINEERING, INC.

1756 Automation Parkway, San Jose, CA 95131 U.S.A.
Telephone:[1](408) 263-5333 Fax:[1](408) 263-0119

A&D MERCURY PTY. LTD.

32 Dew Street, Thebarton, South Australia 5031 AUSTRALIA
Telephone:[61](8) 8301-8100 Fax:[61](8) 8352-7409

A&D INSTRUMENTS LTD.

Unit 24/26 Blacklands Way Abingdon Business Park,
Abingdon, Oxon OX14 1DY UNITED KINGDOM
Telephone:[44](1235) 550420 Fax:[44](1235) 550485

<German Sales Office>

Große Straße 13 b 22926 Ahrensburg GERMANY
Telephone:[49](0) 4102 459230 Fax:[49](0) 4102 459231

A&D KOREA Limited

Manhattan Bldg. 8F, 36-2 Yoido-dong, Youngdeungpo-gu, Seoul, KOREA
Telephone:[82](2) 780-4101 Fax:[82](2) 782-4280

A&D RUS CO., LTD.

Vereyskaya str.112 Kuntsevo Block, 121357,
Moscow, Russia
Telephone: [7] (495) 937-33-44 Fax: [7] (495) 937-55-66