

BIOBASIC

USER MANUAL

Models: 210, 310 & 410

Before You proceed

This user manual is intended for the **BIOBASIC** product series.

We recommend that you read this user manual through thoroughly before using the cabinet. Gram Commercial A/S does not guarantee safety if the appliance is used for anything other than its intended use. Contents of the manual can be subject to change without notice. No part of this manual may be published or reproduced in any form without expressed written consent of Gram Commercial A/S. Gram Commercial A/S guarantees the appliance under certain warranty conditions. Gram Commercial A/S is in no way responsible for any loss or damage of content.

Your feedback is much appreciated, feel free to email us at: info@gram-bioline.com



Manufactured by Gram Commercial A/S

Aage Grams Vej 1

DK-6500 Vojens

Denmark

+45 7320 1300

www.gram-biobasic.com

Item number **765041746** Rev.: **241117**

Language: **English**



Contents

Before You proceed	2
Contents	3
Intended use	4
Temperature setpoint range and ambient requirements	4
Symbols used	5
Installation	6
Initial setup steps	6
Adjusting the base	7
Anti tilt bracket	8
Wall mounting.....	9
Surroundings	10
Product inspection	10
Voltage free contact	11
Connecting to electricity	12
Start up	14
The digital display controls.....	15
General introduction to the controller interface	16
Alarm settings.....	17
Buttons and useful shortcuts	17
Operation parameters	18
Error codes.....	19
Sensor offset	20
Ordinary use	22
Regular maintenance	23
Cleaning.....	23
Door gaskets	24
General info	25
Reversing of door	26
IMPORTANT	27
Disposal	28
Declaration of Conformity	29
Wiring diagrams	30
Piping diagram	32
Notes	33

Intended use

The BIOBASIC range of refrigerators (RR) and freezers (RF), are designed and manufactured to provide general purpose storage solutions for laboratory items.

The BIOBASIC range complies with EN/IEC 60079-15, covering electrical apparatus in Category 3, Zone 2 locations where gas atmospheres may be present.

Enabling placement of BIOBASIC refrigerators and freezers, in Zone 2 areas categorised according to EN/IEC 60079-15.

Temperature setpoint range and ambient requirements

model + temperature setpoint range	Minimum ambient operating temperature	Maximum ambient operating temperature
BIOBASIC 210, 310, 410		
RR with solid door: +2/+15 °C	+10 °C	+35 °C
RR with glass door: +2/+15 °C	+10 °C	+32 °C
RF: -25/-5 °C	+10 °C	+35 °C

Symbols used



Hazard



Risk of electric shock



Risk of material damage



Risk of personal injury



Risk of burning / freezing



Info

Installation

Initial setup steps

- ① Due to safety and operating reasons, the cabinet must not be used outdoors. The cabinet should be installed in a dry and sufficiently ventilated area. To ensure efficient operation, the cabinet should not be installed in direct sunlight or close to heat sources.



Avoid placement of the cabinet in a chloric/acidic environment due to risk of corrosion.

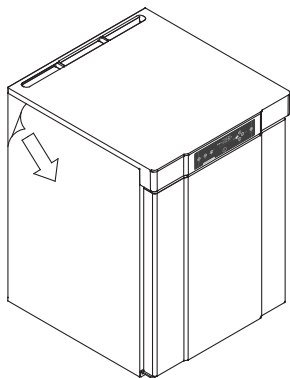

Certain cabinets are shipped with a protective film that should be removed prior to putting the cabinet into service.

Clean the cabinet with a mild soap solution prior to use.



If the cabinet has been laying down (e.g. during transport.).

The cabinet must stand up-right for 24 hours prior to being turned on.



Adjusting the base

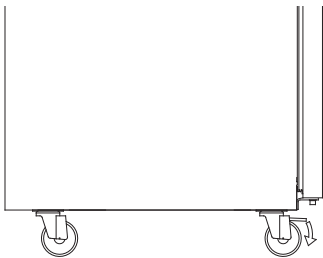
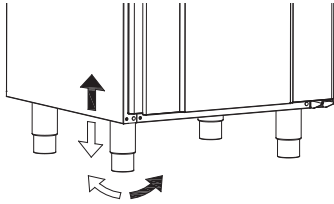
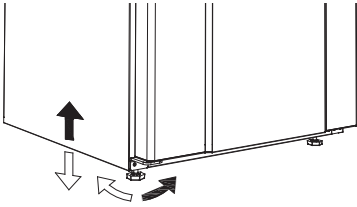

Cabinets equipped with legs should be levelled as shown in the illustrations to the left.



For cabinets equipped with castors, the floor must be level to ensure stable positioning and safe use. When the cabinet is positioned, the 2 front castors should be locked.



Installation

Anti tilt bracket



Cabinets with drawers and/or glass door must be secured to a stable vertical surface, ensuring that the cabinet can not tip over when the drawers are drawn to the outermost position, or the door is open. Brackets for securing the cabinet are included from the factory. Find the instructions for the tilt bracket below.

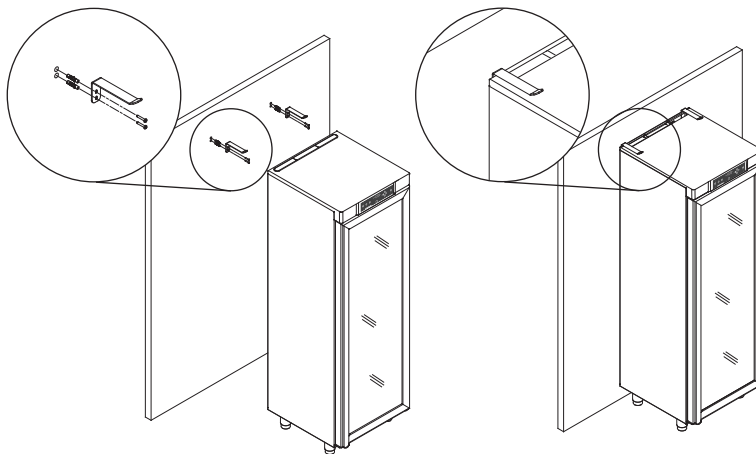

The anti-tilt brackets must be fitted when installing the cabinet, ensuring that the users, surroundings and stored items are not damaged.





Wall mounting

Wall mounting brackets can be supplied if specified. Allowing the cabinet to be lifted from the floor. Find instructions on wall mounting of a BIOBASIC 210 below, the same procedure applies for mounting 310 and 410.

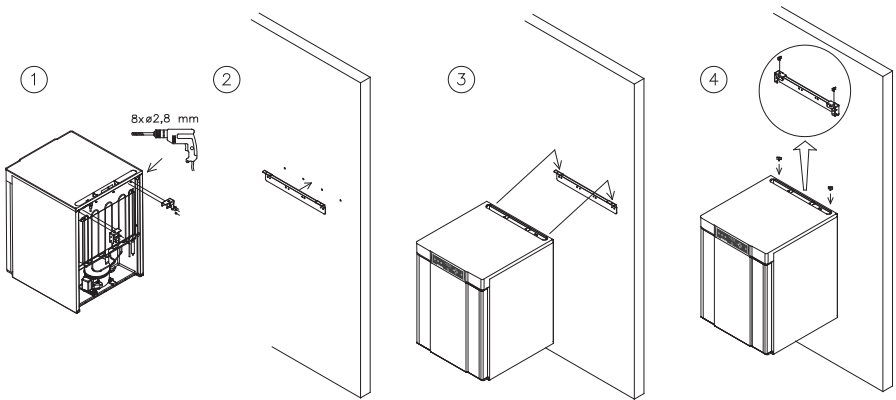

Installation

Surroundings

 There must be at least a 30mm gap between cabinets and/or walls.

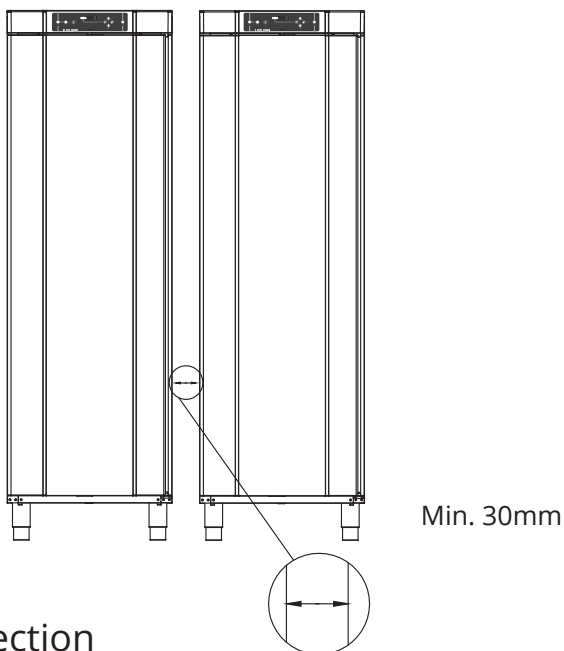

Product inspection

 A visual inspection of the cabinet must be conducted prior to putting the cabinet into service. Check the cabinets structural integrity, that door frames and doors don't have deformities, gaskets seal properly and the doors sit flush up against the door frame.



Voltage free contact

The illustration below shows the three connectors for the relay (e.g. in connecting to CTS or other external monitoring systems). The three connections, are respectively Common, NO (Normally Open) and NC (Normally Closed).

The moment voltage is applied, the controller draws the relay, this makes it possible for the controller to respond to both high and low temperature alarms, door alarms and power failures. Find instructions on setting the alarms in the controller settings section.



Normally closed circuit (NC)

Location of the voltage free contact

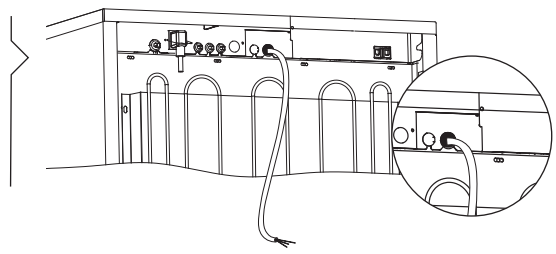

Connection of the voltage-free contact should be done by a qualified installer.

Installation

Connecting to electricity

When setting up in an ordinary scenario that is not subject to regulations for EN 60079-15 zone 2:

The appliance may be connected in accordance with applicable local heavy current regulations.

Note that there are special regulations for products that are in accordance with EN 60079-15 zone 2.

The appliance has been manufactured in accordance with EN 60079-15: Electrical apparatus for explosive gas atmospheres - Part 15: Type of protection "n". Zone 2 is the applicable zone. If the appliance is to be installed in a zone 2 environment, specialist personnel should perform the installation, or be consulted beforehand, in order to ensure that the appliance is installed in compliance with the guidelines currently contained in the standard.

The cabinet is intended for connection to alternating current. The connection values for voltage (V) and frequency (Hz) are given on the type/number-plate.

The power cord from the mains is plugged in the terminal box on the back of the cabinet. The plug is then fixated in place by the hanger that is built into the terminal box. Please note that the hanger should be fitted tightly around the plug, as shown.

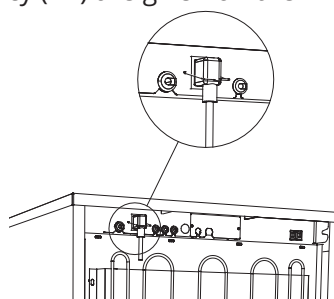



In case of technical difficulties or breakdowns, always contact authorized service personnel. Never dismantle the terminal box or any other electrical component.

The appliance must be connected to the external power supply using a suitable device which mechanically prevents the plug and socket from being separated unintentionally. The connection must be labelled:

"DO NOT SEPARATE WHEN ENERGIZED" .

Fuses and similar must never be removed or replaced while the appliance is connected to a power source. The electrical terminal box must never be opened while the appliance is connected to a power source. The compressor starting equipment must never be dismantled while the appliance is connected to a power source. The LED lighting must never be dismantled while the appliance is connected to a power source. Whenever electrical components are dismantled or replaced, the appliance must be moved to an area in which there is no risk of ignition caused by the electrical components or gases contained in the appliance. Never use the cabinet if the plug is damaged. The cabinet should be examined by a Gram Commercial A/S authorised service technician in such cases.

In both cases:

Use a three-wire plug, if the power outlet is intended for a three-wire plug, the lead in green / yellow insulation should be connected to the ground terminal. Power must be connected via a wall socket. The wall socket should be easily accessible. All earthing requirements stipulated by the local electricity authorities must be observed. The cabinet plug and wall socket should then give correct earthing. If in doubt, contact your local supplier or authorized electrician.

Start up

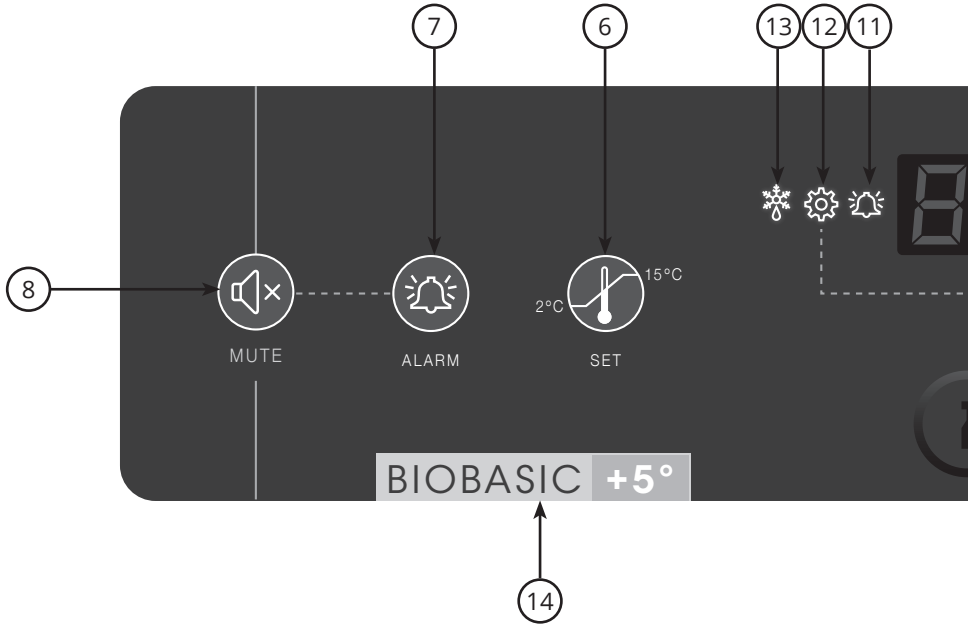

- ① On/Off
- ② Select or confirm a menu parameter
- ③ Navigate upwards in a given menu / raise a given value
- ④ Navigate downwards in a given menu / lower a given value
- ⑤ Parameter settings menu / go a menu-step back
- ⑥ Setpoint temperature setting
- ⑦ Temperature alarm settings
- ⑧ Acknowledge alarm, mute for 5 minutes

The digital display controls

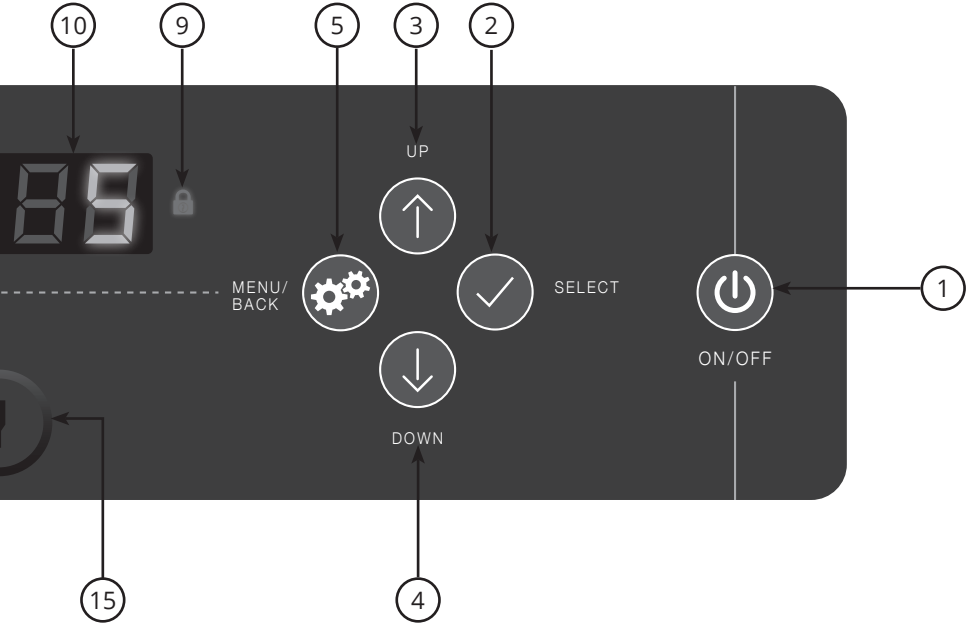

- ⑨ Key pad lock engaged
- ⑩ Display
- ⑪ Temperature- and/or door-alarm registered
- ⑫ Parameter settings menu is open
- ⑬ Defrost in progress
- ⑭ Visual distinction between refrigerator or freezer
- ⑮ Door lock

Start up

General introduction to the controller interface

Turn On/Off:





Press shortly  to turn the cabinet on and press for 6 seconds to turn the cabinet off.

Initiation procedure:

Readout of the software version and variant will occur shortly after turning the cabinet on. The cabinet will then automatically start a defrost-cycle, and terminate it again after a system check. The cabinet is ready when the temperature is displayed.

The cabinet will always commence operation when initially connected to a power supply. For instance after a power outage or when plugging the cabinet in for the first time.

Setpoint temperature adjustments:

Temperature adjustments are done by pressing  for 3 seconds, prompting the set point temperature. Adjust the set point temperature by either pressing  or . Confirm the settings by pressing .

Servicing:

Make sure the appliance is switched off at the socket before service is performed on the cabinet. It is not sufficient to switch off the cabinet on the On/Off  button, as current will persist in some electrical parts of the cabinet.



If fuses or similar are to be replaced, the appliance must be moved to a no-risk area for safe replacement.

















Alarm settings

Press  for 3 seconds to enter the alarm settings

Alarm settings 	↵	Unit	
	HL	[° C]	High temperature alarm limit. Code for activated alarm [A2]
	LL	[° C]	Low temperature alarm limit. Code for activated alarm [A3]
	Hd	[Min.]	Delay of high temperature alarm
	Ld	[Min.]	Delay of low temperature alarm
	dA	On/off	Door alarm. Code for activated alarm [A1]. [1=on / 0=off]
	dAd	[Min.]	Delay of door alarm
	bU	On/off	Acoustic signal for alarm codes [A1], [A2] and [A3]. [1=on / 0=off]

Buttons and useful shortcuts



Buttons:	Press for:	Function:
	-	Acknowledge alarm, mute for 5 minutes
	> 3 seconds	Access the alarm settings
	> 5 seconds	Access the parameter settings
	> 3 seconds	Adjust/show setpoint temperature value
 + 	> 3 seconds	Manually start or stop a defrost
 + 	> 6 seconds	Activating / deactivating the keypad lock
	-	Show highest registered temperature spike (since the last reset of alarm and temperature history)
	-	Show lowest registered temperature spike (since the last reset of alarm and temperature history)
 + 	> 3 seconds	Clear and reset alarm and temperature history
 +  + 	> 6 seconds	Restores factory settings

Operation parameters



Please note - changing operation parameters without the expressed consent from Gram Commercial A/S can have unintended implications on performance and potentially void warranty.

Press  for 5 seconds to enter operation parameters.

Operation parameters 	↵	Unit	
	CA	[° K]	Offset of A-sensor. Reference sensor for refrigeration and alarm system
	d1		Number of defrosts per 24 hours (4 is factory setting)
	d2	[° C]	Termination temperature in the evaporator during a defrost
	Li	On/off	*Only for glass door models* - Turn light on or off
	tEr	 ↵	Relay test / Component test
	tC	[° C]	Test compressor relay
	tF	[Min.]	Test evaporator fan
	td	[Min.]	Test defrost element relay (RF models)
	tA	[Min.]	Test alarm relay (will trip voltage free)
	tdP	On/off	Test display
Sensor read-out	P-A	[° C]	Test output of A-sensor
	P-B	[° C]	Test output of B-sensor



Error codes

Display code	Explanation
- 0 -	Door is open
A1	Door alarm "dAd" has been activated
A2	High temperature alarm "HL" is or has been activated
A3	Low temperature alarm "LL" is or has been activated
F1	Error on the main cabinet sensor. The refrigeration system will use an emergency program to make the cabinet run. Temperature stability will be affected. Service is required
F2	Error on the evaporator sensor. Service is required



In order to assure the safety of the stored items, the alarms should be supported by external alarms. This can be done by utilizing the possibility of the voltage-free contact.

Please find instructions for connecting the "voltage-free contact" in the "Installation" section.





Sensor offset

Sensor offset is used in cases where there are deviations in the cabinet's actual operation compared to control measurements by independent temperature measuring systems.

The A-sensor is used to manage the cabinets refrigeration system, and is also the reference sensor for the display and alarms.

The A-sensor is offset if the actual temperature in the cabinet does not match the setpoint, despite taking the hysteresis into consideration. Offset of A sensor is named "CA".

Offsetting the A-sensor

- ↳ Press and hold  for more than 5 seconds
- ↳ Press  to select "CA"
- ↳ Press  +  to offset the A-sensor
- ↳ Press  to confirm the set value

The A-sensor is now offset, proceed to other parameters by pressing

, and then navigate by using  or 

- ↳ Leave the user menu by pressing  several times until the cabinet temperature is shown in the display.



① **Practical example of offsetting:**

Example 1 - The temperature in the cabinet is operating colder than the actual setpoint.

With a setpoint of +4°C, the actual temperature inside the cabinet is between +2 and +4°C. The desired temperature range is between +3 and +5°C. This means that "CA", in this case, should be -1,0K, so that the refrigeration system stops 1,0K before and starts 1,0K later than the setpoint normally otherwise would dictate.

Example 2 - The temperature in the cabinet is operating warmer than the actual setpoint.

With a setpoint of +4°C, the actual temperature inside the cabinet is between +4 and +6°C. The desired temperature range is between +3 and +5°C. This means that "CA", in this case, should be 1,0K, so that the refrigeration system stops 1,0K later and starts 1,0K earlier than the setpoint normally otherwise would dictate.

Ordinary use



The cabinet is not suited for storing items that emit vapours, as they might corrode the cabinet and its components.

All the items stored in the cabinet that are not sealed, or wrapped, should be covered to reduce the risk of corrosion of the cabinet and its components.

Items placed on the bottom of the cabinet will cause the air circulation to be impeded, reducing the cabinets performance.

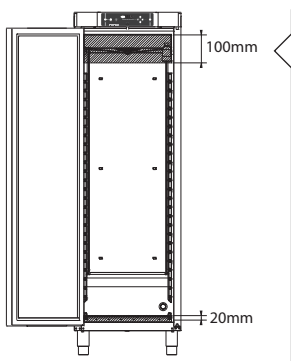

Keep the marked areas in the cabinet (shown on this page) clear of all items, ensuring adequate air circulation, and therein cooling.

Do not place items beneath the lowest shelf bracket.

Items should be evenly distributed in the cabinet, with minimum layer-thickness / maximum surface. And at the same time, the air should be able to circulate freely between the items.

Regular maintenance



Cleaning

Always disconnect the cabinet before cleaning.

The cabinet should be cleaned internally with a mild soap solution (Max. 85°C) at suitable intervals and checked thoroughly before it is put into operation again.

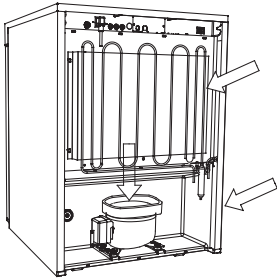

The compressor compartment and in particular the condenser must be kept free from dust and dirt. This is best done with a vacuum cleaner and a brush. Do not flush compressor compartment or evaporator with water as this may cause short-circuits in the electrical system.



It is recommended that the re-evaporation tray is cleaned at least once a year. This shall only be done while the cabinet is turned off.

Be careful not to damage the defrost water tube and heating element (located in the tray) when cleaning.



Cleaning agents containing chlorine or compounds of chlorine as well as other corrosive agents, may not be used, as they might cause corrosion to the stainless panels of the cabinet and the evaporator system.

Door gaskets

Door gaskets are an important part of a cabinet, door gaskets with impaired functionality reduces a cabinets seal with the door. Impaired seals can lead to increased humidity in the storage chamber, iced evaporator (and thus reduced cooling capacity), and in some cases, decreased lifetime expectancy of the cabinet. It is therefore very important to be aware of the door gaskets condition. Regular inspections are recommended.

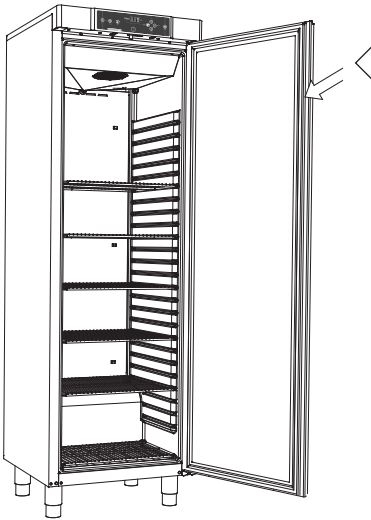

The door gasket should be cleaned regularly with a mild soap solution.

If a gasket is to be replaced, please contact your local Gram BioLine distributor.

General info



Is the cabinet being used for purposes other than its intended use, or use of the cabinet is not in accordance with guidelines specified in the user manual, the user bears full responsibility for any consequences thereof.

Defective parts must be replaced with original parts from Gram Commercial A/S. Gram Commercial A/S can only guarantee functional and safety requirements on the cabinets, if above-mentioned is adhered to.



The cabinets refrigeration components should at least be checked once a year by a Gram Commercial A/S technician or a similar professional.

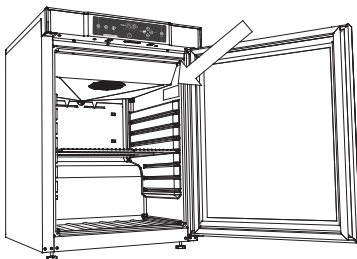

Quote the serial number (SN) of a cabinet when referring to it. This information can be found on the type/number-plate located on the inside of the storage chamber.

Reversing of door

Applicable to cabinets without self close device and glass door



1. Switch off the power at the mains socket.
2. Dismantle the two screws that hold the control panel at front and back, pull the panel a little forward, and then tilt it upwards.
3. Dismantle the hinge at pos. A, and lift off the door.
4. Dismantle the hinge at pos. B, and mount it at pos. F.
5. Turn the door 180°, and fix it at the hinge pos. F.
6. Mount the hinge from pos. A in pos. D, and move bracket from pos. C to pos. E.
7. Fasten the control panel again. Apply power to the cabinet.

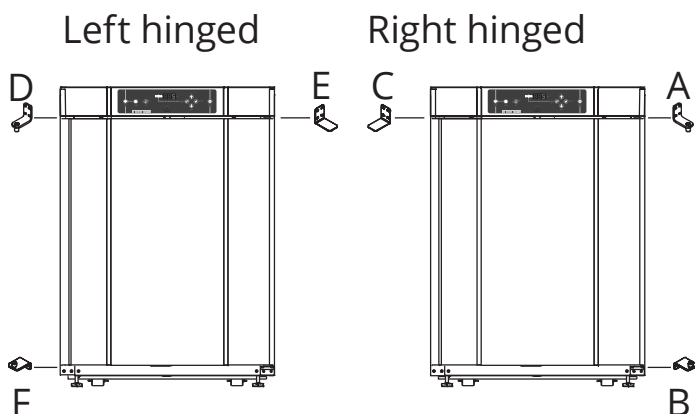

IMPORTANT



There may occur sharp edges on the cabinet housing, compressor room, and interior furnishings. Show due diligence when handling the cabinet, neglect of these precautions can lead to injuries.

Danger of wedging in the frame slot between the door and the cabinet, show due diligence when opening and closing the cabinet door. Negligence of these precautions can lead to injuries.

Danger of wedging in the drawer column between the drawers and interior of the cabinet, show due diligence when using the drawers. Negligence of these precautions can lead to injuries.

Unlocked castors can lead to unexpected movements of the cabinet. Lock the castors after installation. Negligence of these precautions can lead to injuries.

The re-evaporation tray, re-evaporation tray heating element, pressure pipes and compressors develops considerable heat during operation. Assure that these components are sufficiently tempered before touching. Negligence of these precautions can lead to injuries.

The evaporator develops considerable cold during operation. Assure that the evaporator is sufficiently tempered before touching. Negligence of this precaution may lead to injuries.

The fan may cause injury during operation, avoiding touching the fans while the cabinet is connected to the mains. Negligence of these precautions can lead to injuries.

Do not use electrical appliances inside the cabinet.

Disposal

Electrical and electronic equipment (EEE) contains materials, components and substances that can be dangerous and harmful to human health and the environment if the waste (WEEE) is not disposed of properly.



Products that are labelled with a “crossed-out wheeled bin” is electric and electronic equipment. The crossed out wheeled bin symbolizes that waste of this type can not be disposed of with unsorted municipal waste, but must be collected separately.

Contact your local BioLine distributor when the cabinet needs to be disposed of.

For additional information, see our website:

www.gram-biobasic.com

Declaration of Conformity



English EC Declaration of Conformity

We, **Gram Commercial A/S** declare under sole responsibility that the following products:

Name: **GRAM BIOBASIC**
Model: 210, 310 & 410
Refrigerant: R134a & R600a

To which this declaration relates, is in compliance with all the applicable essential requirements, and other provisions of the European Council Directive.

Directive of the European Parliament and of the Council:
- ATEX Directive 2014/34/EU - Pressure Equipment Directive 2014/68/EU - Directive for Machinery 2006/42/EU - Low Voltage Directive 2014/35/EU - EMC Directive 2014/30/EU

Product compliance has been demonstrated on the basis of:

Harmonized Standards:	Text:
DS/EN 61010-1: 2010	Safety requirements for electrical equipment for measurement, control, and laboratory use - Part 1: General requirements.
DS/EN 61326-1: 2013	Electrical equipment for measurement, control and laboratory use. EMC requirements. General requirements.
DS/EN 60079-0: 2012	Electrical apparatus for explosive atmospheres.
DS/EN 60079-11: 2012	Explosive atmospheres - Part 11: Equipment protection by intrinsic safety "i".
DS/EN 60079-15: 2010	Explosive atmospheres - part 15: Type og protection "n".
DS/EN 60079-25: 2010	Explosive atmospheres - part 25: Intrinsically safe systems.
DS/EN 60704-1: 2010	Household and similar electrical appliances - Test code for the determination of airborne acoustical noise - Part 1: General requirements.
DS/EN ISO 3744: 2010	Acoustics - Determination of sound power levels of noise sources using sound pressure - Engineering method in an essentially free field over a reflecting plane.
DS/EN ISO 9001: 2008	Quality management systems.

Gram Commercial A/S
Aage Grams Vej 1
DK-6500 Vojens
Telephone: + 45 73 20 13 00

Vojens, 03.10.2016

John B. S. Petersen
Approval Manager

Wiring diagrams

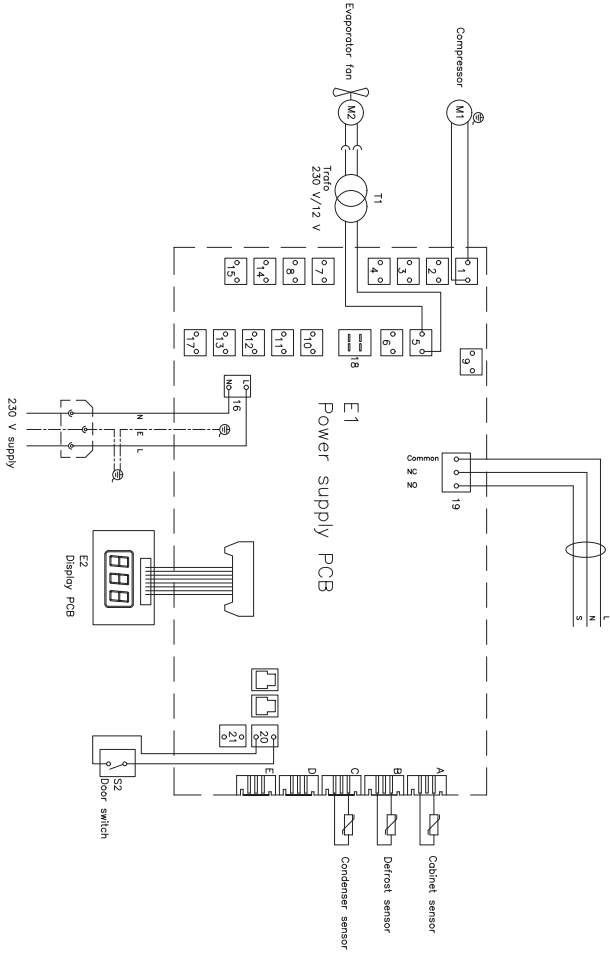

Revision:		General Information:	
Description: E1—diagram BIOPASIC RR 210/310/410		ISO 2768-2 (1)	3
Date: 31-08-2015		Scale: 1/1	1
Drawing no.: 765072819		Rev.:	1
Issue: 1/1		Rev.:	1
© 2015 General Motors		Rev.:	1
All rights to this drawing belong to General Motors. All use of this drawing is prohibited without the written permission of General Motors. All rights reserved.		Rev.:	1

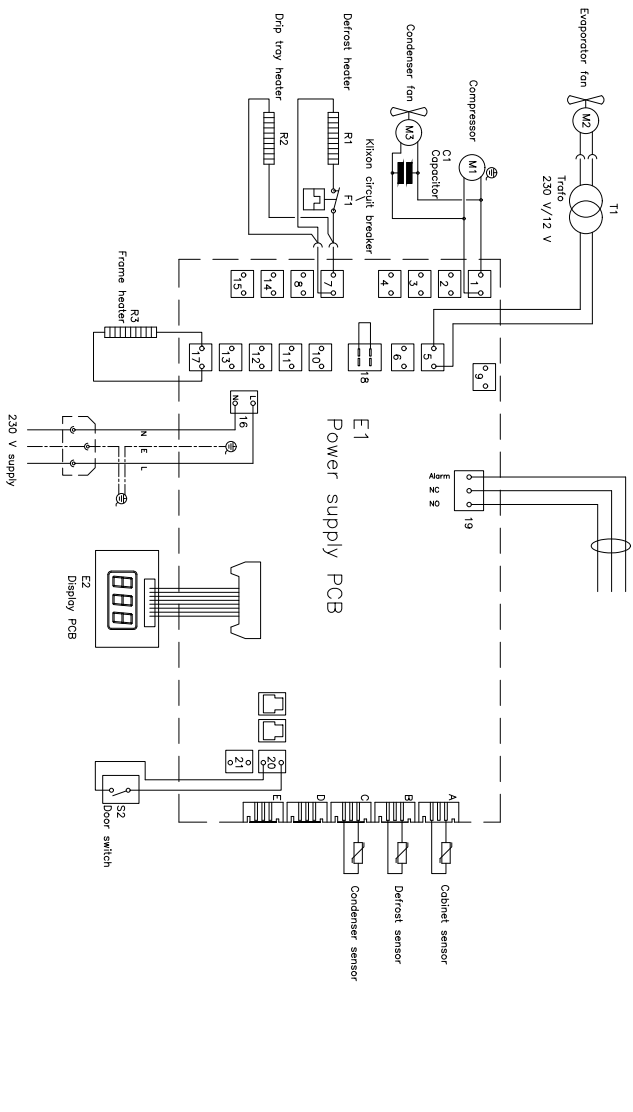

Revision:		General Information:	
Description: EI—diagram BIOBASIC RF 210/310/410		ISO 2768-1 (M)	3
		ISO 2768-2 (L)	1
Date: 31-08-2015		Drawing no.:	A
Author: JPP		Scale: 1/1	Rev.:
Checked: DSW		765072820	1
© Dem. Commercial M/S			1
Scale: 1/1			001

All rights in this drawing belong to Dem. Commercial M/S. If use of copyright, that the drawing should not be reproduced or transmitted in any form or by any means, without our written permission be copied, presented or passed over to a third person. Misuse will lead to prosecution.

Piping diagram

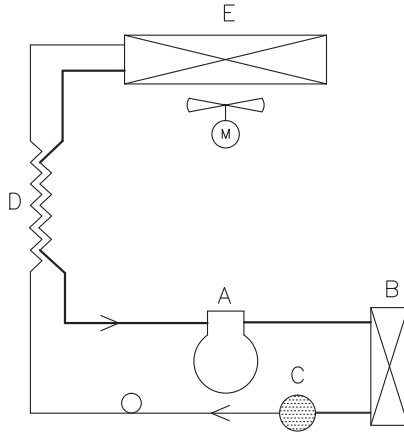

	DK	GB	D
A	Kompressor	Compressor	Kompressor
B	Kondensator	Condenser	Verflüssiger
C	Tørrefilter	Filter drier	Trockenfilter
D	Varmedveksler	Heat exchanger	Wärmeaustauscher
E	Fordamper	Evaporator	Verdampfer

Revision:

Description: Rørdiagram BIOBASIC		General tolerances: ISO 2768-1 (m) ISO 2768-2 (L)			
 © Gram Commercial A/S DENMARK	Date: 05-04-2016	Drawing no.:	Sheet no.:	Rev.	A format
	Name: JABP	765041931	of	000	
	Scale:				

All rights to this drawing belongs to Gram Commercial A/S, cf. law of Copyright. Thus the drawing should not without our written permission be copied, presented or passed over to a third person. Misuse will lead to prosecution.

Notes



Notes





Gram Commercial A/S
Aage Grams Vej 1
DK-6500 Vojens
Tel. +45 7320 1300
Info@gram-bioline.com

Item number **765041746** Rev.: **241117**
Language: **English**

BIOBASIC