

°LAUDA

°LAUDA



OVERALL BROCHURE CONSTANT TEMPERATURE EQUIPMENT 2020/2021

°FAHRENHEIT. °CELSIUS. °LAUDA.

LAUDA

Worldwide

LAUDA-Noah, LP

2501 SE Columbia Way, Suite 140
Vancouver, WA 98661 • USA
T +1 360 993 1395 • info@lauda-noah.com

new.degree

The LAUDA Innovation Lab

440 North Wolfe Road
Sunnyvale, CA 94085 • USA
T +1 408 829-5287 • info@new.degree

LAUDA-Brinkmann, LP

1819 Underwood Boulevard • Delran, NJ, 08075 • USA
308 Digital Drive • Morgan Hill, CA 95037 • USA
T +1 856 764 7300 • info@lauda-brinkmann.com

LAUDA América Latina Tecnología Ltda.

Av. Paulista, 726 – 17º andar – Cj. 1707
01310-910 – São Paulo • SP Brazil
T +55 11 3192-3904 • info@lauda.net.br

LAUDA Ultracool S.L.

C/ Colom, 606 • 08228 Terrassa (Barcelona) • Spain
T +34 93 7854866 • info@lauda-ultracool.com

LAUDA Ibérica Soluciones Técnicas, S.L.

C/ Colom, 606 • 08228 Terrassa (Barcelona) • Spain
T +34 93 7854866 • info@lauda-iberica.es

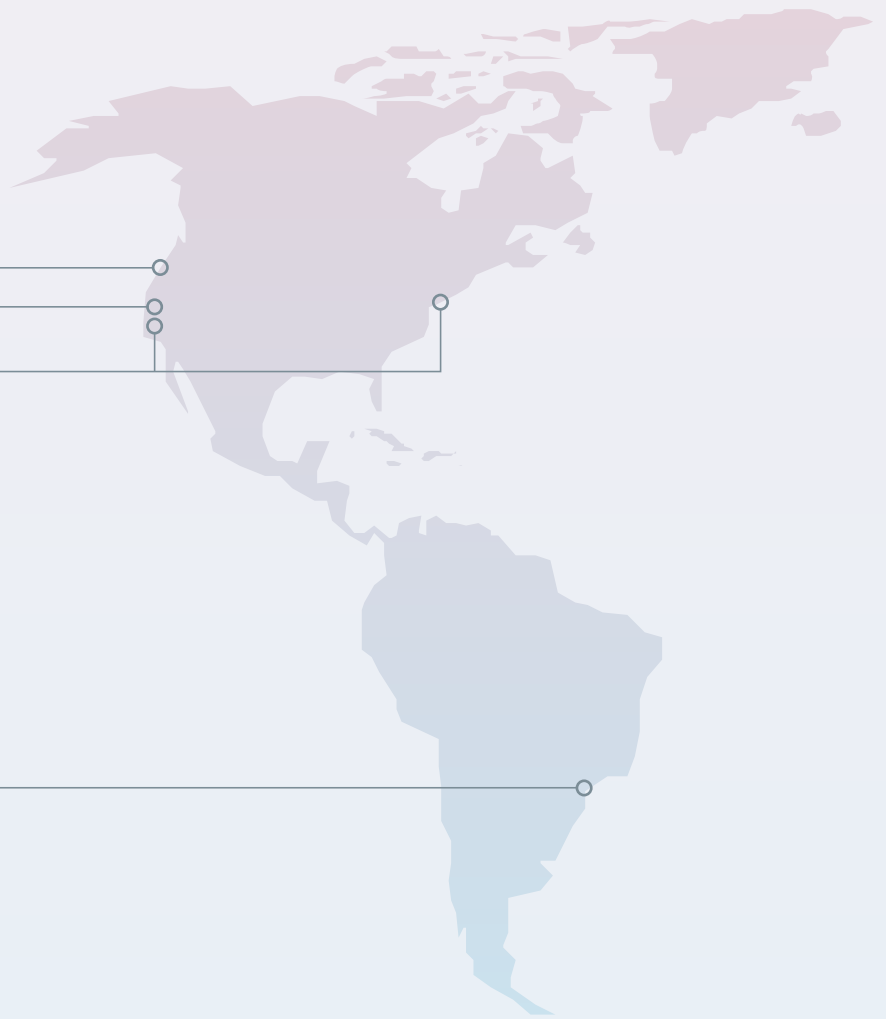

LAUDA Technology Ltd.

Unit 12 · Tinwell Business Park
Stamford, PE9 3UN · United Kingdom
T +44 (0)1780 243 118 · info@lauda-technology.co.uk

LAUDA-GFL Gesellschaft für Labortechnik mbH

Schulze-Delitzsch-Straße 4 · 30938 Burgwedel
Germany · T +49 (0) 5139 9958-0 · info@lauda-gfl.de

ООО «LAUDA Восток»

Malaja Pirogovskaja Str. 5 · 119435 Moscow
Russia · T +7 495 9376562 · info@lauda.ru

LAUDA DR. R. WOBSEER GMBH & CO. KG

Pfarrstraße 41/43 · 97922 Lauda-Königshofen
Germany · T +49 (0)9343 503-0 · info@lauda.de

LAUDA Production China Co., Ltd.

Room A , 2nd floor, Building 6 · No. 201 MinYi Road
Song Jiang District · 201612 Shanghai · China
T +86 10 57306210 · info@lauda.cn

LAUDA China Co., Ltd.

2nd floor, Building 6 · No. 201 MinYi Road
Song Jiang District · 201612 Shanghai · China
T +86 21 64401098 · info@lauda.cn
Office Beijing · 15/F, Office Building A
Parkview Green 9 Dongdaqiao Road,
Chaoyang District · 100020 Beijing · China
T +86 10 57306210 · info@lauda.cn

LAUDA Italia S.r.l.

Strada 6 – Palazzo A – Scala 13
20090 Assago Milanofiori (MI) · Italy
T +39 02 9079194 · info@lauda-italia.it

LAUDA France S.A.R.L.

ZAC du Moulin · 25 rue Noyer · CS 11621
95724 Roissy Charles de Gaulle Cedex · France
T +33 (0)1 39926727 · info@lauda.fr

LAUDA Singapore Pte., Ltd.

25 International Business Park · #04-103M German Centre
Singapore 609916 · Singapore · T +65 6563 0241 · info@lauda.sg

LAUDA

A world market leader with tradition

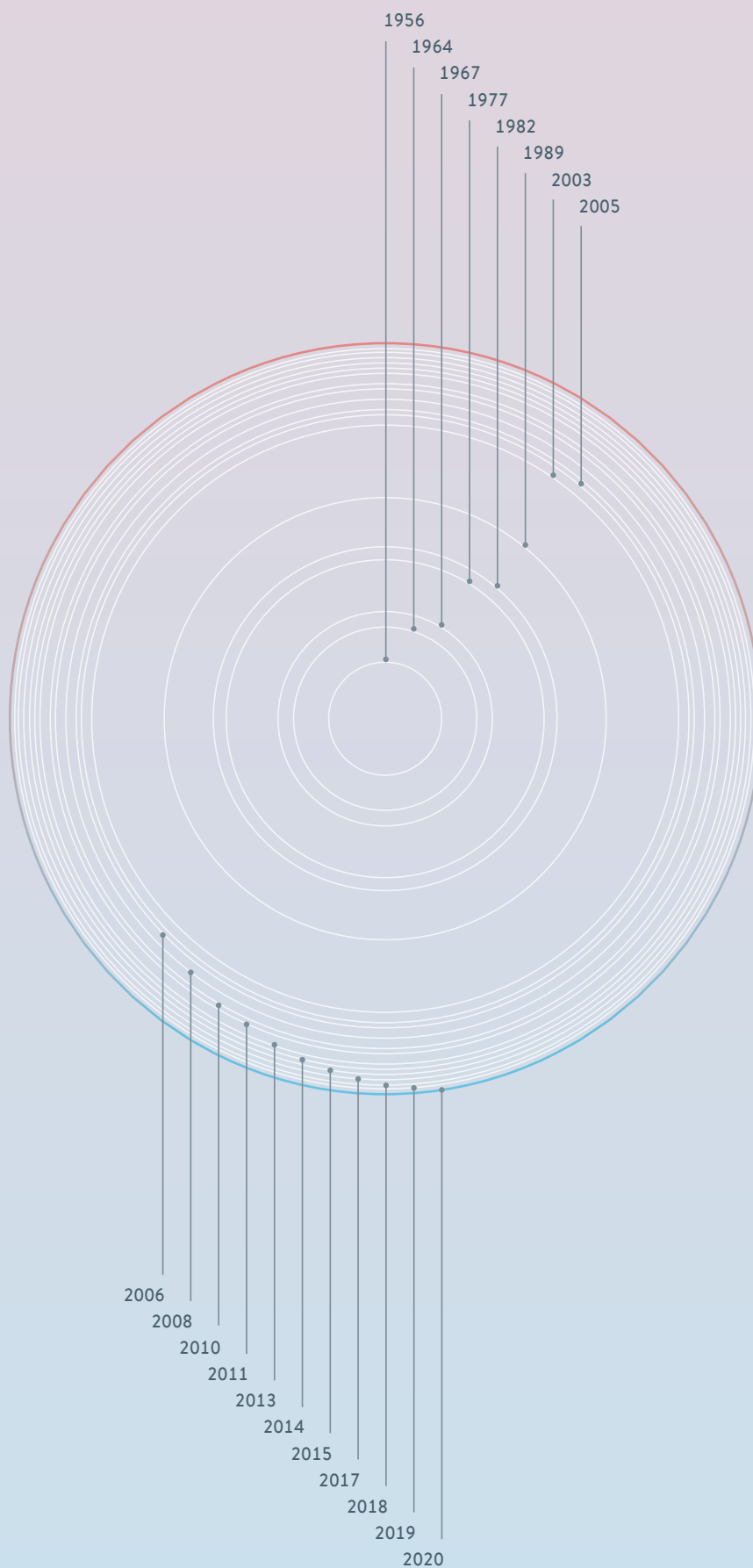

1956	The first year	Dr. Rudolf Wobser founds Messgerätewerk Lauda Dr. R. Wobser KG in the small town of Lauda in Baden.
1964	The first industrial systems	Since 1964, LAUDA has also been building industrial heating and cooling systems for technology centers and production.
1967	The first measuring instruments	Market launch of pioneering LAUDA innovations: such as the first tensiometer and first film weighing scales.
1977	Dr. Gerhard Wobser and Karlheinz Wobser take over the management	After their father's death, the two brothers take up the role of Managing Director and share responsibilities accordingly.
1982	The first thermostat with a microprocessor	LAUDA introduces the world's first thermostats featuring microprocessor technology and invents features such as proportional cooling and external control.
1989	The first year under today's company name	Renaming of company with expansion of product range: from Messgerätewerk Lauda Dr. R. Wobser KG to LAUDA DR. R. WOBSEK GMBH & CO. KG.
2003	Dr. Gunther Wobser appointed Managing Director	Karlheinz Wobser retires. Dr. Gunther Wobser, at LAUDA since 1997, becomes the new Managing Director.
2005	Subsidiary LAUDA France	First subsidiary LAUDA France is founded to support and advise customers and agencies on the market.
2006	50 years of LAUDA	LAUDA celebrates its 50th anniversary on March 1, 2006.
2008	Global expansion phase with new subsidiaries	LAUDA America Latina C.A., LAUDA China Co. Ltd. and LAUDA-Brinkmann, LP, USA, are founded.
2010	Dr. Gerhard Wobser resigns	His son, Dr. Gunther Wobser, takes over his duties.
2011	Acquisition of LAUDA Ultracool	LAUDA expands its product range with industrial circulation chillers by acquiring LAUDA Ultracool S.L. in Barcelona.
2013	New building	Opening of a new logistics center and production hall.
2014	Expansion LAUDA-Noah	LAUDA buys US company Noah Precision and expands the product range with thermo-electric thermostats.
2015	Independent company for measuring devices	The new subsidiary LAUDA Scientific takes over development, sales and service activities for LAUDA measuring.
2017	Progress with Peltier technology	An innovative thermo-electric circulation thermostat, the LAUDA LOOP, enables location-independent temperature control.
2018	New branding for LAUDA	LAUDA is introducing a confident new corporate design with a redesigned logo and new slogan.
2019	Acquisition of GFL and digital innovation	LAUDA acquires the traditional company GFL, thereby expanding its expertise in lab technology. LAUDA advances the digitalization of temperature control technology with the new Integral and Ultracool product lines.
2020	New benchmarks in device design	LAUDA transitions all its product lines to a consistent and ultra-modern new design.

LAUDA

Applications according to sectors

RESEARCH AND DEVELOPMENT LABORATORIES



In research and development, temperature control is particularly important in the areas of sample preparation and quality assurance. As part of the sample preparation, a pre-tempering takes place in many cases. Many processes in quality assurance require the observance of a defined temperature or the targeted change of the temperature in a defined time.

Typical applications

- Sample preparation
- Quality assurance
- Research laboratory

AUTOMOTIVE



Temperature control in the automotive sector is mainly found in test benches and material tests. All components of the automobile are exposed to particularly high temperature fluctuations. Great importance is attached to component testing on special test benches. The simulation of environmental conditions such as high or low temperatures is an important part of material testing.

Typical applications

- Test bench applications
- Material testing

BIOTECHNOLOGY



In biotechnology, temperature control is essential to the quality of research and production results. Constant temperatures in the operation of bioreactors contribute significantly to the success of the products. As part of sample preparation, there are a variety of work steps that require reliable temperature control.

Typical applications

- Bioreactors
- Sample preparation

CHEMISTRY



In the chemical industry, there are many processes where temperature control plays an important role, including reactor temperature control and process engineering. At tempering processes in reactors, applications such as chemical reactions, syntheses, production of drug substances, polymerizations or crystallizations take place.

Typical applications

- Reactor temperature control
- Process engineering

PHARMACEUTICAL INDUSTRY



In the pharmaceutical industry, the temperature control processes range from research to production scale. To obtain high-quality reaction products, temperature control systems must reliably control the process sequence in an external reactor.

Typical applications

- Reactor temperature control
- Process engineering

SEMICONDUCTOR INDUSTRY



In the production of semiconductors and the testing of electronic components, there are numerous processes that must be exactly tempered. These include, for example, the organometallic chemical vapor phase deposition (MOCVD) in semiconductor coating as a precursor of LED production. Other typical temperature-dependent investigations in the semiconductor industry include stress tests for function and load testing, environmental simulations, and in-circuit tests of electronic assemblies.

Typical applications

- Process cooling
- Component testing

AEROSPACE



Temperature simulations and temperature-dependent material tests are an important component in the aerospace industry. Cyclic temperature stress tests ensure that a trouble-free usage of the components used is always ensured, even under extremely fluctuating external conditions in space.

Typical applications

- Material testing
- Temperature simulation

MEDICAL TECHNOLOGY



In medical technology, temperature control is found primarily in the laboratory for sample preparation and in medical devices such as imaging machines, medical lasers or devices used in pharmaceutical and medical laboratories.

Typical applications

- Medical laboratory
- Medical device

PRINTING INDUSTRY



Constant temperature control plays a central role in quality assurance in the printing and paper technology industry. Digital printing machines need a constant flow of cooling water to ensure high print quality, print speed and reliability. Reliable temperature control technology also ensures a high-quality end product on cutting, punching and perforating machines.

Typical applications

- Digital printing machines
- Digital cutting and perforating machines

MECHANICAL AND PLANT ENGINEERING

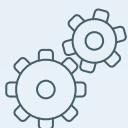

In mechanical engineering, even small deviations from the set temperature can compromise quality, reduce the service life of the machine and increase the risk of breakdown. Reproducible production processes on laser cutting machines or high-precision machine tools can only be ensured by constant temperature control.

Typical applications

- Laser cutting machines
- UV curing and UV drying
- Precision machine tools

LAUDA Group

The essential facts

For more than 60 years, we have been the only company in the world to guarantee the perfect temperature in research, application technology and production for more than 10,000 customers with our 520 employees, a turnover of more than 90 million euro and 15 production and distribution companies overseas. LAUDA quality products control temperature with up to 400 kilowatts of cooling capacity and maintain constant temperatures or heat to the nearest five-thousandth of a °C within a range of -150 to 550 °C.

90.000.000

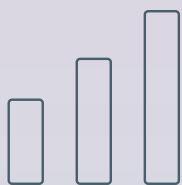

Revenue in euro

520

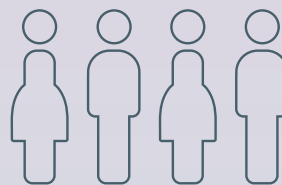

Employees

95

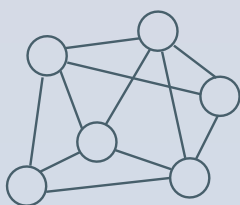

Number of representatives

135



Supported countries

5



Production companies

10



Distribution companies

41%

Constant temperature
Equipment

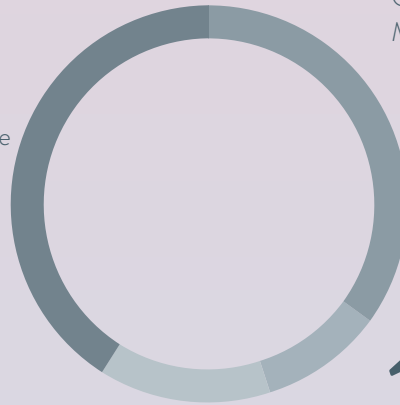

35%

Original Equipment
Manufacturer

10%

Service

14%

Heating and cooling systems

Portion of overall turnover 2019

Business units

CONSTANT TEMPERATURE EQUIPMENT

From water baths to high-performance process thermostats: LAUDA thermostats are characterized by their excellent handling, highly ergonomic design and intuitive operation and provide a working temperature range from -100 to 320 °C.

HEATING AND COOLING SYSTEMS

Heating and cooling to the accuracy of a tenth degree in a temperature range from -150 to 550 °C: with tailor-made systems for industrial applications according to modular engineering principles.

ORIGINAL EQUIPMENT MANUFACTURER

Customer-specific advice with corresponding instrument selection and development of individual temperature control solutions for an optimum cost-benefit ratio with decades of successful partnerships.

SERVICE

High product quality and comprehensive professional services form an inseparable unit at LAUDA. Regular care, service and maintenance by highly qualified LAUDA service specialists ensures the high performance of your LAUDA devices.



LAUDA WINS: WITH PRODUCTS, SAFETY AND SERVICE – AND PEACE OF MIND.



Large selection

Whether it's for routine tasks, professional and economical temperature control, high cooling outputs and high cooling rates or lightning-fast temperature changes – LAUDA has the right solution for almost every requirement.



Exemplary safety concepts

All products meet the most stringent safety requirements and provide peace of mind in every application, thanks to the intelligent technologies and sophisticated safety concepts.



Easy handling

All LAUDA devices are characterized by excellent handling, a highly ergonomic design and intuitive operation. They also offer maximum user convenience and future-oriented software.



First-class advice – internationally

The LAUDA team provides friendly, fair, and expert advice. LAUDA application experts help customers worldwide to configure application-optimized systems.



Proverbial quality

For more than 60 years, LAUDA has been developing, designing and producing high-quality constant temperature equipment to the highest standards in quality and safety – confirming time and again the durability and longevity that LAUDA has become known for.



Reliable service

Robust LAUDA devices are known for their durability. If you still need additional support, we will not let you down: with quick access to comprehensive services – for greater flexibility and cost-efficiency.

LAUDA

Overview



WATER BATHS

Hydro P.16

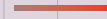

HEATING THERMOSTATS

Alpha P.32

ECO P.34

PRO P.36

Proline Bridge thermostats P.38

Proline Clear-view thermostats P.40

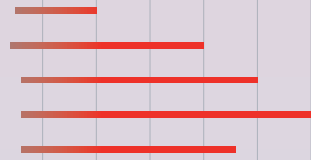

COOLING THERMOSTATS

Alpha P.56

ECO P.58

PRO P.60

Proline Kryomats P.62

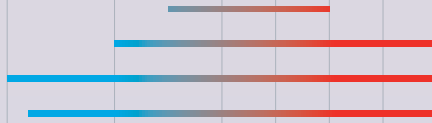

CIRCULATION AND PROCESS THERMOSTATS

LOOP P.80

PRO P.82

Integral T P.84

Integral XT P.86

Variocool P.88

Kryoheater Selecta P.90

Semistat P.92

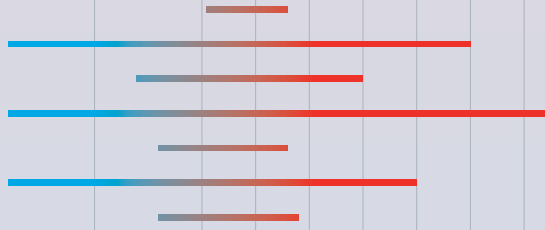

CIRCULATION CHILLERS

Microcool P.114

Variocool P.116

Ultracool P.118

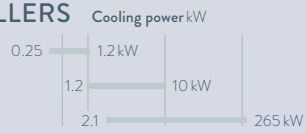

CALIBRATION THERMOSTATS

ECO P.138

Proline P.140

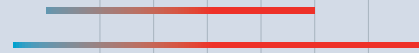

HEAT TRANSFER LIQUIDS P.146

ACCESSORIES P.148

LAUDA WATER BATHS

Specific application examples

- Preparation of cellular, biological or medical samples
- Incubation of microbiological tests
- Preparation of environmental samples
- Defrosting of samples
- Conducting of chemical reactions



LAUDA Hydro water baths

from 25 to 100 °C



Reliable and universal water baths

LAUDA offers a significantly expanded range of laboratory technology with six water baths and two water baths with a circulating function. The new LAUDA Hydro water baths with a high-quality stainless steel interior provide the right bath depth and opening for every application with bath volumes from 4 to 41 liters. All water baths have a temperature range of up to 100 °C with a temperature stability of ± 0.1 K, which also permits applications in the boiling temperature range. A TFT display ensures intuitive operation with a temperature display in °C and °F.



High-quality, welded stainless steel bath interior, equipped with a sieve plate as standard



Large, high-contrast TFT display with menu-guided controls

HEATING PERFORMANCE Heat transfer liquid: Water, bath closed

Bath temperature °C

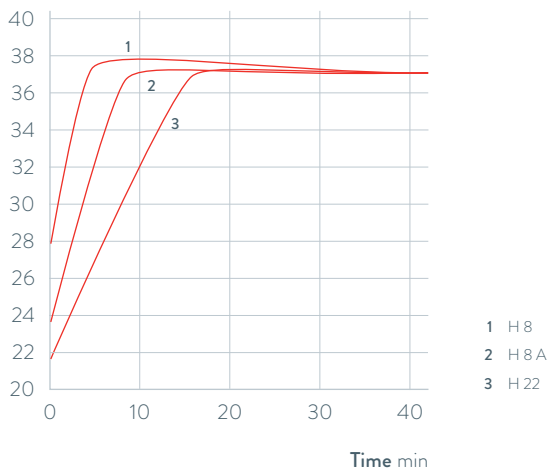

- 1 H8
- 2 H8A
- 3 H22

Important functions

- Three user-specific timer functions
- Direct temperature control for rapid heating
- Visual and acoustic alarm in case of water shortage, over-/under-temperature as well as sensor break
- Lid design prevents condensation from dripping back on samples

Standard equipment

Double-walled, heat-insulating stainless steel lid and drain tap

Additional accessories

Adjustable water level controller, rack for test tubes of different diameters and baby milk bottles

All technical data and power supply variants can be found in the »Technical data« section.

More at www.lauda.de/de/1780



LAUDA Hydro water baths

The new LAUDA Hydro water baths are optimally equipped for every laboratory application and ensure homogeneous temperature distribution without local overheating. LAUDA Hydro water baths with precision temperature distribution and optional circulation are designed for the requirements of biological, medical and biochemical laboratories.



LAUDA Hydro shaking water baths

from 10 to 99,9 °C

10 °C  99,9 °C

Reliable, maintenance-free shaking water baths

The shaking water baths of the LAUDA Hydro series can be used for a variety of tasks in the laboratory depending on requirements. The device type H 20 SOW creates a circular motion for the sample whereas the types H 20 S and H 20 SW are designed for a linear, oscillating shaking movement.

The built-in speed controller of the new LAUDA Hydro shaking water baths enables a load-independent, infinitely variable shaking movement with a soft start. The two shaking water baths H 20 SW and H 20 SOW are equipped with a cooling coil as standard. The temperature range of the shaking water baths can be extended down to +10 °C by connecting them to commercially available circulation chillers, such as the LAUDA Microcool.



Drain valve on the back of the device



Operation left: Temperature adjustment with LED display, right: Speed adjustment of the shaking unit



Bath interior completely made of stainless steel: shaking basket, heating element, cover frame, lid

Important functions

- Digital temperature adjustment and indication via LED display
- Load-independent, continuously variable shaking device with a gentle start-up
- Electronic function monitoring of the temperature controller, two independent under and overtemperature protection fuses
- Bath body, cover frame with condensation channel, shaking basket and heater made of stainless steel

Additional accessories

Adjustable water level controller, perforated shaking tray for fastening of clips for Erlenmeyer flasks and various racks for test tubes and Falcon tubes

All technical data and power supply variants can be found in the »Technical data« section.

More at www.lauda.de/de/1781



LAUDA Hydro shaking water baths

Shaking water baths in the LAUDA Hydro device line move samples in the laboratory with a linear or orbital shaking movement, depending on the model. LAUDA Hydro shaking water baths are reliable companions for continuous operation in daily laboratory work.



LAUDA Hydro vaporization water baths

from 25 to 100 °C

25°C  100°C

High-performance, robust vaporization baths

The special baths for gentle vaporization work from columns, Erlenmeyer flasks or beakers are suitable for unattended continuous operation in the laboratory, thanks to water level controllers and water shortage protection. The new LAUDA Hydro vaporization water baths are available in five models, all equipped with a removable hole cover with a multi-piece ring set, made of heat-resistant plastic.



H 6 V vaporization water bath with four openings and support rods as standard for secure fastening of vaporization vessels



H 11 V with stainless steel external housing, specially designed for use in fume hoods

Important functions

- Temperature setting via a rotary knob with temperature scale
- Different number of openings
- Removable hole cover consisting of a multi-piece ring set
- H 11 V and H 19 V with a stainless steel external housing, especially for digestories for fume hoods
- Adjustable water level controller as standard

Additional accessories

Stainless steel support rod for H 5 V

All technical data and power supply variants can be found in the »Technical data« section.

More at www.lauda.de/de/1782



LAUDA Hydro vaporization water baths

LAUDA Hydro vaporization baths operate in a temperature range from 25 to 100 °C. The opening diameter of the water bath can be variably changed in approx. 20 mm increments by means of the multi-piece ring set. The models H 11 V and H 19 V are specially designed for protected working use in fume hoods. The housings are made of stainless steel to allow evaporation work with chemically aggressive chemical media.



LAUDA Hydro tissue float baths

from 25 to 80 °C

25°C — 80°C

User-friendly and reliable tissue float baths

Tissue float baths are used in histological, chemical, clinical and bacteriological labs for the stretching and drying of cut tissue samples. The precise temperature control of the new LAUDA Hydro tissue float baths ensures evenly stretched samples that are clearly visible inside the bath and guarantees gentle drying of the stretched samples on the heated edge.



Adjustable bath temperature with heating activity display

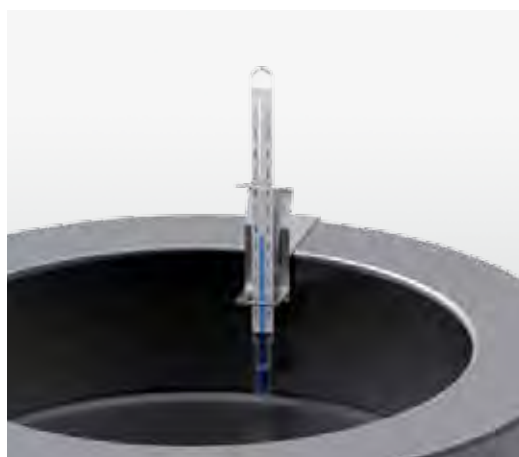

Temperature display via thermometer

Important functions

- Temperature setting via a rotary knob with temperature scale
- Temperature display via reference thermometer on the edge of the bath
- Bath interior in black anodized aluminum

Additional accessories

Dust protection cover

All technical data and power supply variants can be found in the »Technical data« section.

More at www.lauda.de/de/1783

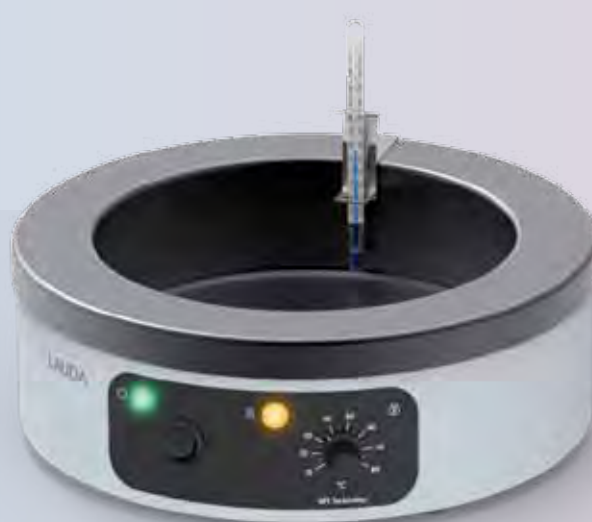

LAUDA Hydro paraffin stretching baths

The new LAUDA Hydro tissue float baths function within a temperature range of 25 to 80 °C with a temperature stability of ± 0.5 K. The bath body is made of black anodized aluminum. The low bath height enables work to be carried out safely and easily.



LAUDA Water baths

Device type overview

LAUDA Hydro / Page 16

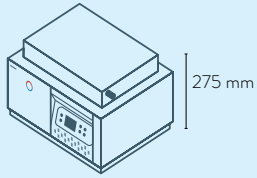

H 4

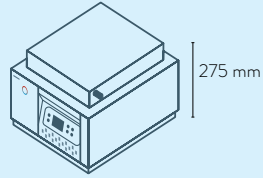

H 8

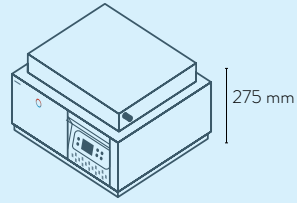

H 16

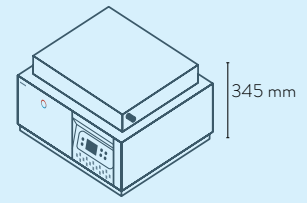

H 22

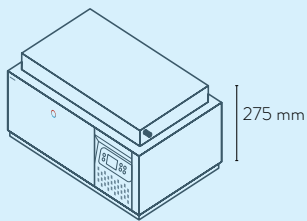

H 24

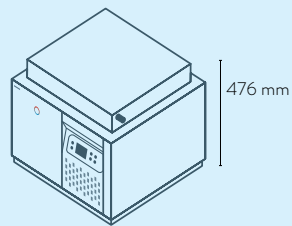

H 41

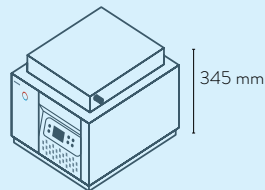

H 8 A

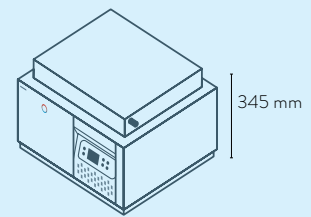

H 16 A

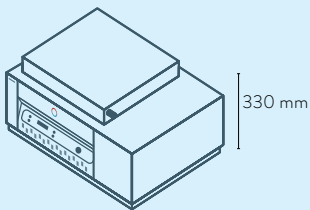

H 20 S
H 20 SW

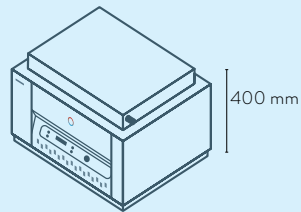

H 20 SOW

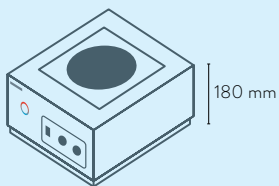

H 5 V

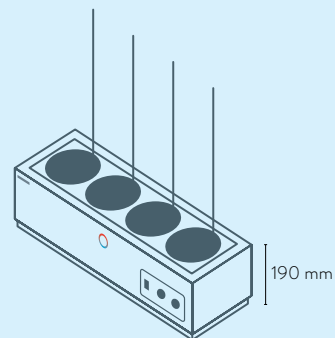

H 6 V

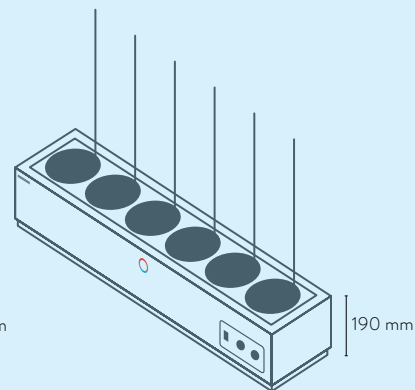

H 9 V

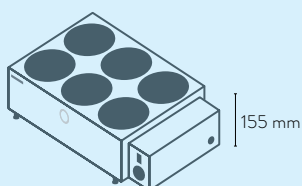

H 11 V

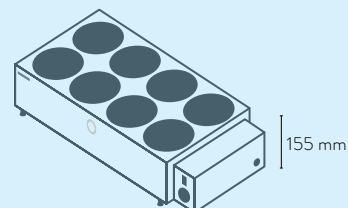

H 19 V

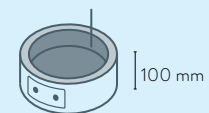

H 2 P

LAUDA Water baths

Technical data according to DIN 12876 standard

Device type*	Working temperature range °C	Working temperature range with water cooling °C	Temperature stability ±K	Safety fittings	Heater power max. kW	Shaking amplitude mm	Shaking frequency U/min	Movement type*	Bath volume min. L	Bath volume max. L	Number of bath openings	Bath opening (W x D) mm
LAUDA Hydro / Page 16												
H 4	25 ... 100	-	0.10	I, NFL	0.5	-	-	-	1.9	3.5	1	245×100
H 8	25 ... 100	-	0.10	I, NFL	1.0	-	-	-	3.8	7.0	1	245×200
H 16	25 ... 100	-	0.10	I, NFL	1.5	-	-	-	7.5	13.9	1	400×245
H 22	25 ... 100	-	0.10	I, NFL	1.5	-	-	-	7.5	20.3	1	400×245
H 24	25 ... 100	-	0.10	I, NFL	1.5	-	-	-	11.3	20.9	1	600×245
H 41	25 ... 100	-	0.10	I, NFL	1.5	-	-	-	9.3	37.9	1	410×296
H 8 A	25 ... 100	-	0.10	I, NFL	1.0	-	-	-	3.8	7.0	1	245×200
H 16 A	25 ... 100	-	0.10	I, NFL	1.5	-	-	-	7.5	13.9	1	400×245
H 20 S	25 ... 99.9	-	0.10	I, NFL	1.5	22	10 ... 250	B	9.0	24.4	1	450×300
H 20 SW	25 ... 99.9	10 ... 99.9	0.10	I, NFL	1.5	22	10 ... 250	B	9.0	24.4	1	450×300
H 20 SOW	25 ... 80	10 ... 80	0.10	I, NFL	1.5	14	10 ... 250	O	8.5	23.1	1	450×300
H 5 V	25 ... 100	-	3.00	I, NFL	1.0	-	-	-	-	5.0	1	Ø 192
H 6 V	25 ... 100	-	3.00	I, NFL	1.0	-	-	-	-	5.3	4	Ø 131
H 9 V	25 ... 100	-	3.00	I, NFL	1.5	-	-	-	-	8.0	6	Ø 131
H 11 V	25 ... 100	-	3.00	I, NFL	1.5	-	-	-	-	10.5	6	Ø 91
H 19 V	25 ... 100	-	3.00	I, NFL	1.5	-	-	-	-	18.4	8	Ø 111
H 2 P	25 ... 80	-	0.50	I, NFL	0.3	-	-	-	-	1.6	1	Ø 200

*A = Agitation (water bath with circulating system) O = Orbital (circular motion) B = Bidirectional (linear or back and forth motion)

Bath depth mm	Usable depth mm	Height top of bath mm	Dimensions (W x D x H) mm	Weight kg	Power supply V; Hz	Loading max. kW	Cat. No.	Device type
165	115	218	340×290×275	7.4	230 V; 50/60 Hz	0.5	L002900	H 4
165	115	218	340×395×275	9.3	230 V; 50/60 Hz	1,0	L002901	H 8
165	115	218	500×440×275	13.3	230 V; 50/60 Hz	1.5	L002902	H 16
225	180	278	500×440×345	15.0	230 V; 50/60 Hz	1.5	L002903	H 22
165	115	218	700×440×275	17.2	230 V; 50/60 Hz	1.5	L002904	H 24
335	285	388	510×490×476	21.2	230 V; 50/60 Hz	1.5	L002905	H 41
165	115	218	340×395×345	10.9	230 V; 50/60 Hz	1.0	L002906	H 8 A
165	115	218	500×440×345	15.2	230 V; 50/60 Hz	1.5	L002907	H 16 A
160	110	277	715×520×330	28.0	230 V; 50/60 Hz	1.5	L002908	H 20 S
160	110	277	715×520×330	30.0	230 V; 50/60 Hz	1.5	L002909	H 20 SW
160	110	347	635×505×400	35.0	230 V; 50/60 Hz	1.5	L002910	H 20 SOW
-	120	180	342×400×180	8.1	230 V; 50/60 Hz	1.0	L003066	H 5 V
-	90	190	682×232×190	12.4	230 V; 50/60 Hz	1.0	L003067	H 6 V
-	90	190	982×232×190	17.0	230 V; 50/60 Hz	1.5	L003068	H 9 V
-	100	155	450×300×155	5.7	230 V; 50/60 Hz	1.5	L003069	H 11 V
-	100	155	690×300×155	7.9	230 V; 50/60 Hz	1.5	L003070	H 19 V
60	50	100	280×280×100	2.0	230 V; 50/60 Hz	0.3	L003071	H 2 P

LAUDA Water baths

Power supply variants

Device type	Power supply V; Hz	Loading max. kW	Plug code*	Cat. No.	Device type	Power supply V; Hz	Loading max. kW	Plug code*	Cat. No.
LAUDA Hydro / Page 16									
H 4	100 V; 50/60 Hz	0.5	14	L002922	H 5 V	100 V; 50/60 Hz	1.0	14	L003078
H 4	115 V; 60 Hz	0.5	14	L002911	H 5 V	115 V; 60 Hz	1.0	14	L003072
H 8	100 V; 50/60 Hz	1.0	14	L002923	H 6 V	100 V; 50/60 Hz	1.0	14	L003079
H 8	115 V; 60 Hz	1.0	14	L002912	H 6 V	115 V; 60 Hz	1.0	14	L003073
H 16	100 V; 50/60 Hz	1.5	14	L002924	H 9 V	100 V; 50/60 Hz	1.5	14	L003080
H 16	115 V; 60 Hz	1.5	14	L002913	H 9 V	115 V; 60 Hz	1.5	14	L003074
H 22	100 V; 50/60 Hz	1.5	14	L002925	H 11 V	100 V; 50/60 Hz	1.5	14	L003081
H 22	115 V; 60 Hz	1.5	14	L002914	H 11 V	115 V; 60 Hz	1.5	14	L003075
H 24	100 V; 50/60 Hz	1.5	14	L002926	H 19 V	100 V; 50/60 Hz	1.5	14	L003082
H 24	115 V; 60 Hz	1.5	14	L002915	H 19 V	115 V; 60 Hz	1.5	14	L003076
H 41	100 V; 50/60 Hz	1.5	14	L002927	H 2 P	100 V; 50/60 Hz	0.3	14	L003083
H 41	115 V; 60 Hz	1.5	14	L002916	H 2 P	115 V; 60 Hz	0.3	14	L003077
H 8 A	100 V; 50/60 Hz	1.0	14	L002928					
H 8 A	115 V; 60 Hz	1.0	14	L002917					
H 16 A	100 V; 50/60 Hz	1.5	14	L002929					
H 16 A	115 V; 60 Hz	1.5	14	L002918					
H 20 S	100 V; 50/60 Hz	1.5	14	L002930					
H 20 S	115 V; 60 Hz	1.5	14	L002919					
H 20 SW	100 V; 50/60 Hz	1.5	14	L002931					
H 20 SW	115 V; 60 Hz	1.5	14	L002920					
H 20 SOW	100 V; 50/60 Hz	1.5	14	L002932					
H 20 SOW	115 V; 60 Hz	1.5	14	L002921					

*All data for the plug codes can be found on page 150

LAUDA

HEATING THERMOSTATS



Specific application examples

- Sample preparation for chemical and pharmaceutical analysis
- Medical serology
- Biotechnology
- Material testing

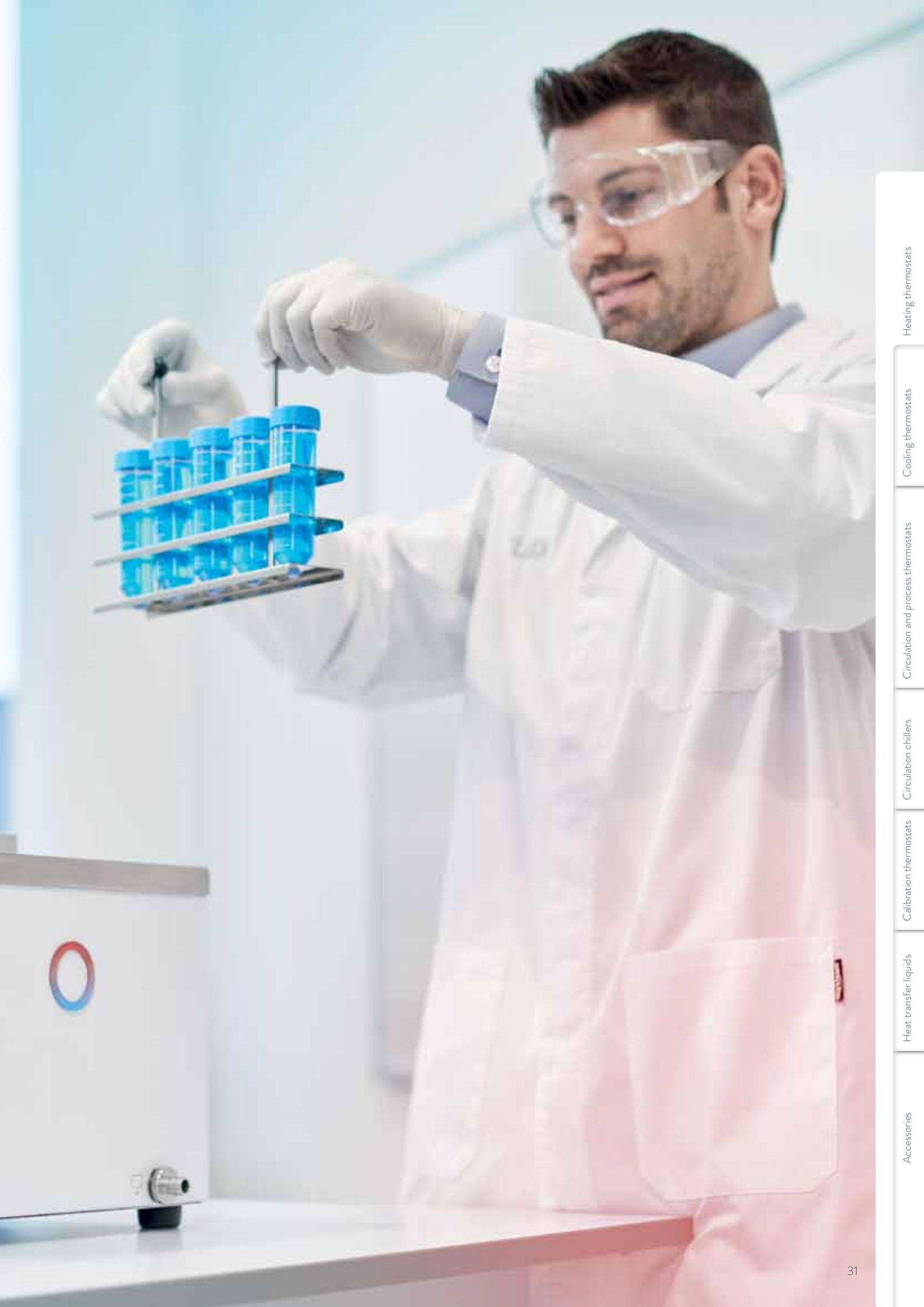

Heating thermostats

Cooling thermostats

Circulation and process thermostats

Circulation chillers

Calibration thermostats

Heat transfer liquids

Accessories

LAUDA Alpha

Heating thermostats from 25 to 100 °C for cost-effective temperature control thermostating in the lab

25°C ————— 100°C

Cost-effective thermostats with reliable technology incorporated into a modern design

LAUDA Alpha is the most cost-effective choice when it comes to premium-quality LAUDA thermostats. These reliable and user-friendly thermostats, with features optimized for essential use, can be operated with non-flammable liquids and are suitable for both internal and external temperature control tasks.



Simple and intuitive menu navigation with three-button operation using a large, clearly legible LED display



Screw clamp allows easy change to different bath vessels with a maximum wall thickness of 30 mm

HEATING PERFORMANCE Water, bath closed

Bath temperature °C

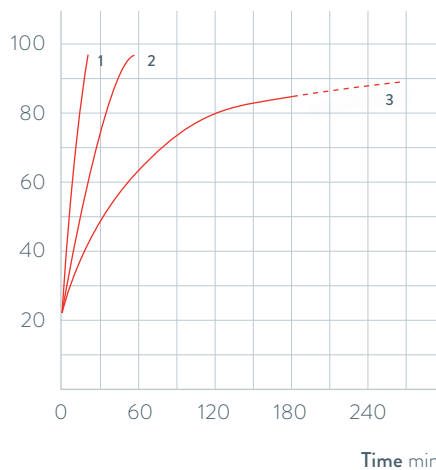

1 A6
2 A12
3 A24

Important functions

- Deep-drawn stainless steel bath vessels
- Integrated timer function allows automatic device shutdown
- Low-level and overtemperature protection for operation with non-flammable liquids

Included accessories

Screw clamp, attachment nozzle in two sizes

Further accessories

Pump circulation set, cooling coil, bath cover set

All technical data and power supply variants can be found in the ›Technical data‹ section.

More at www.lauda.de/1724



LAUDA Alpha

Heating thermostats A6, A12 and A24 work in the temperature range between 25 and 100 °C. Cooling coil, pump circulation set and bath cover set are available as accessories for all thermostats.



LAUDA ECO

Heating thermostats from 20 to 200 °C
for economic temperature control in the lab



Economic and high-performance temperature control

The ECO thermostats come in Silver (LCD display) or Gold (color TFT display) models, equipped with a mini USB interface as standard. The circulation pump can be adjusted to six levels. The ECO heating thermostat line encompasses transparent baths up to 100 °C as well as immersion thermostats and heating thermostats with stainless steel baths up to 200 °C.



Plain text menu navigation on a monochrome LCD (Silver) or color TFT display (Gold) for easy operation



Standard-issue cooling coil included with all heating thermostats

HEATING PERFORMANCE Heat transfer liquid: Therm 240, bath closed

Bath temperature °C

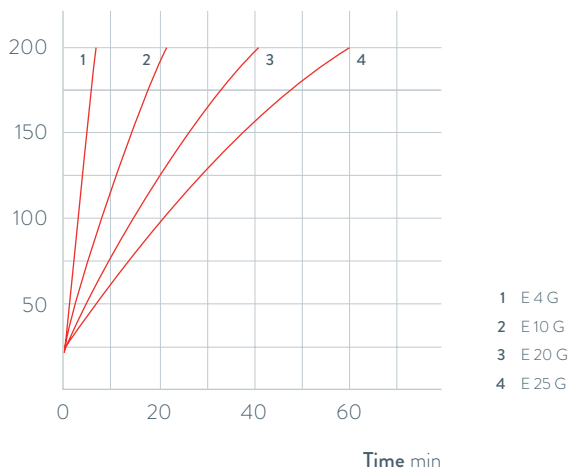

- 1 E 4 G
- 2 E 10 G
- 3 E 20 G
- 4 E 25 G

Important functions

- Integrated programmer for automating temperature profiles
- Adjustment of flow rate switch for internal/external circulation, can be controlled from exterior during operation
- Can be upgraded with Pt100/LiBus module for external control

Included accessories

Cooling coil, bath cover and pump connections (with E 4)

Further accessories

Tubing, bath cover, pump connection set, interface modules

All technical data and power supply variants can be found in the ›Technical data‹ section.

More at www.lauda.de/1726



LAUDA ECO

Bath thermostats come equipped with a cooling coil as standard. The E4 is also equipped with a bath cover and pump connections for external application connections. A drain tap on the back side of the device makes changing the heat transfer liquid in the stainless steel baths easy and safe.



LAUDA PRO

Heating bath thermostats from 30 to 250 °C
for professional temperature control



Flexible operation, outstanding performance characteristics

LAUDA PRO is the cutting-edge product line with an outstanding overall concept: The innovative Base or Command Touch operating units can be detached and used as a remote control. Heating bath thermostats come equipped with a cooling coil as standard.



Low device height and 360° accessibility of the bath thanks to detachable remote control

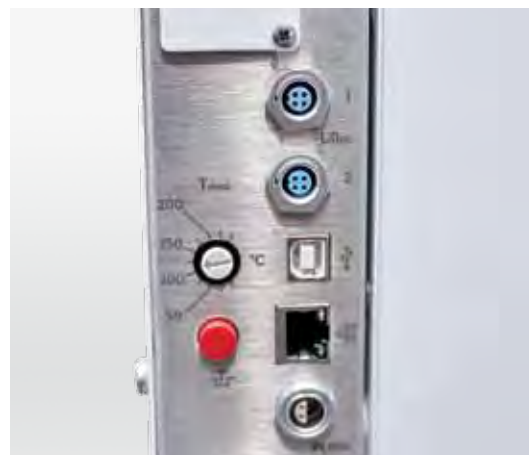

Ethernet and USB interface and Pt100 connection as standard

HEATING PERFORMANCE Heat transfer liquid: Ultra 300, bath closed

Bath temperature °C

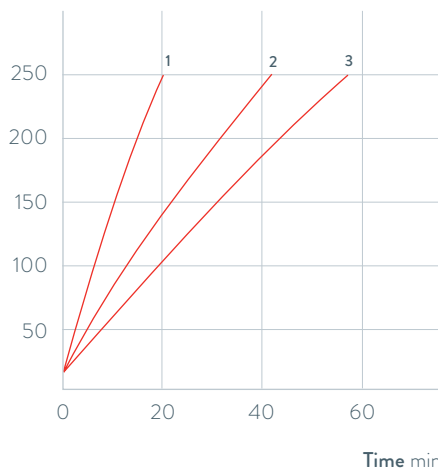

- 1 P10 C
- 2 P20 C
- 3 P30 C

Important functions

- Draining tap on the front of the device
- Operated via Base operating unit with OLED display or Command Touch with color touch screen
- Stainless steel bath vessels (insulated with handles and drain tap)
- Internal LAUDA Vario Pump with 8 selectable output levels
- Ethernet and USB interface and Pt100 connection as standard

Included accessories

Bath cover, tubing nipples with screw caps for the cooling coil

Further accessories

External pump, interface modules

All technical data and power supply variants can be found in the »Technical data« section.

More at www.lauda.de/1728



LAUDA PRO

The PRO heating bath thermostats P10, P20 and P30, with volumes of 10, 20 and 30 liters, function up to a maximum temperature of 250 °C and their excellent temperature stability make them perfect for internal bath applications.



LAUDA Proline bridge thermostats

Bridge thermostats 30 to 300 °C
for temperature control of any bath



Intuitive operation with broad temperature range

The LAUDA Proline bridge thermostats with vario flex pump are great for temperature control of any bath vessel. The PB models have a pressure/suction pump, but the PBD models are equipped with stronger pressure pumps. They enable temperature control on deeper baths of up to 320 mm. A telescoping rod for baths with a width of 310 to 550 mm, an ergonomic handle and side pump connections are also available.



Extendable telescoping rods for placement on baths with widths of 310 to 550 mm



Removable Command remote control unit for easy and intuitive operation

PUMP CHARACTERISTICS for PBD and PBD C, Liquid: Water

Pressure bar

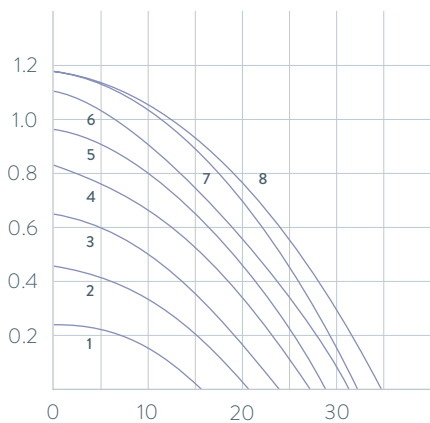

- 1 Step 1
- 2 Step 2
- 3 Step 3
- 4 Step 4
- 5 Step 5
- 6 Step 6
- 7 Step 7
- 8 Step 8

Pump flow L/min

Important functions

- Programmer with 150 temperature/time segments and graphical temperature display with Command control unit
- PowerAdapt system for optimally adapted max. heating output without influencing the mains power supply
- Low-level protection and adjustable overtemperature protection with acoustic alarm. Float for identifying low or high level

Included accessories

Tubing nipples for pump connection, telescoping rod

Further accessories

Automatic filling device, bath vessels, interface modules

All technical data and power supply variants can be found in the »Technical data« section.

More at www.lauda.de/1730



LAUDA Proline bridge thermostats

LAUDA Proline bridge thermostats are available with two different control units. The master version is designed for all applications in which the parameters are not changed very often. The removable Command operating unit offers a graphic LCD screen for high operating convenience and an additional programmer.



LAUDA Proline clear-view thermostats

Heating clear-view thermostats from 30 to 230 °C
in research, application technology and production

30°C 230°C

A clear view of the object at all times

LAUDA clear-view thermostats are optimized for direct observation of objects. They are ideal for use with the fully automatic LAUDA viscometer PVS or iVisc, since the temporal and spacial temperature stability necessary for precise determination of viscosity is guaranteed across the whole temperature range. Furthermore, the two-chamber principle ensures a constant liquid level in the measuring chamber at all times, regardless of the fluid volume and temperature. The PVL models with five layers of insulated glass are suitable for low temperature measurements down to -40 or -60 °C when a flow through chiller or cooling thermostat is connected.



Insulated glass makes it possible to observe samples, even at very low temperatures



Removable Command remote control unit for easy and intuitive operation

HEATING PERFORMANCE Heat transfer liquid: Therm 240, bath closed

Bath temperature °C

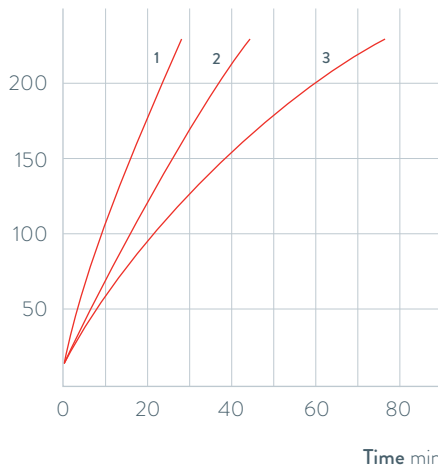

- 1 PV 15 (up to 230 °C)
PVL 15 (up to 100 °C)
- 2 PV 24 (up to 230 °C)
PVL 24 (up to 100 °C)
- 3 PV 36

Important functions

- Programmer with 150 temperature/time segments and graphical temperature display with Command control unit
- LAUDA Vario Flex pump (pressure pump) with eight selectable output levels
- Cooling coil fitted as standard allows connection of an additional cooler

Included accessories

Tubing nipples for pump connection and cooling coil

Further accessories

Solenoid valve for cooling water, additional cooler, interface modules

All technical data and power supply variants can be found in the »Technical data« section.

More at www.lauda.de/1732



LAUDA Proline clear-view thermostats

LAUDA Proline clear-view thermostats are available with two different control units. The master version is designed for all applications in which the parameters are not changed very often. The removable Command operating unit incorporates a graphic LCD screen for high operating convenience and also a programmer.



LAUDA Heating thermostats

Device type overview

LAUDA Alpha / Page 32

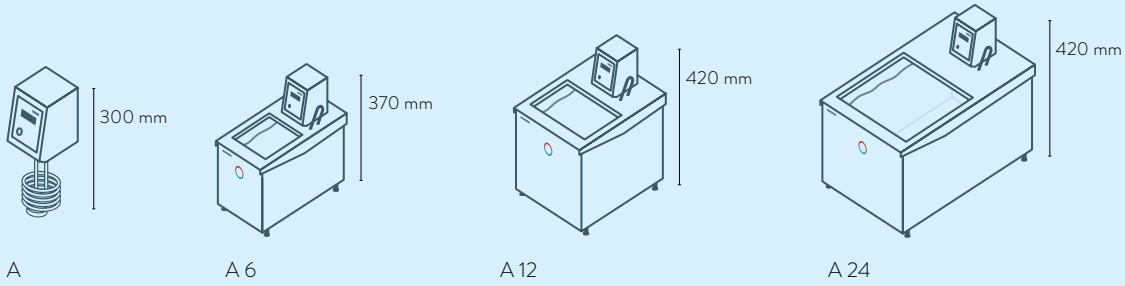

LAUDA ECO / Page 34

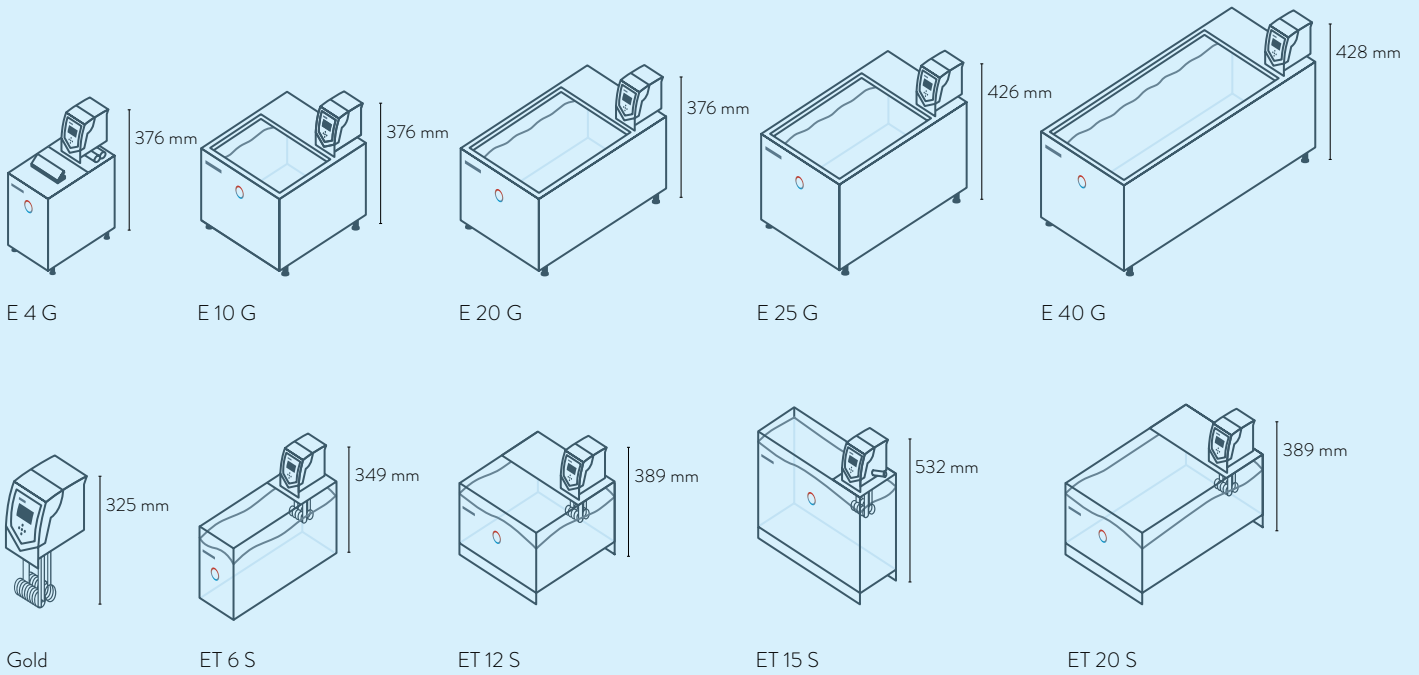

LAUDA PRO / Page 36

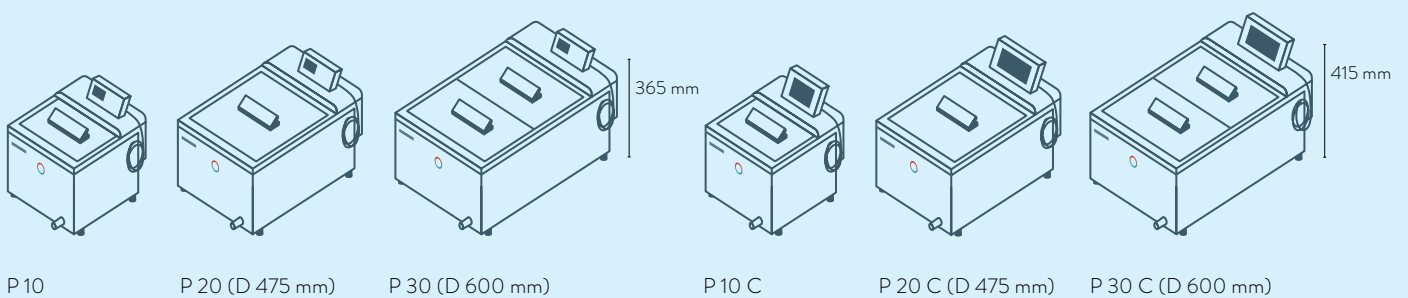

LAUDA Heating thermostats

Interfaces

	Pt 100 (1)	Pt 100 (2)	USB	Ethernet	RS 232 / 485	Analog	Namur contact	Sub-D contact	Profibus	EtherCat M8	EtherCat RJ 45	Number of module slots, large	Number of module slots, small
LAUDA Alpha / Page 32	-	-	-	-	-	-	-	-	-	-	-	-	-
LAUDA ECO / Page 34	Z	-	S	Z	Z	Z	Z	Z	Z	Z	Z	1	1
LAUDA PRO / Page 36	S	-	S	S	Z	Z	Z	Z	Z	Z	Z	1	-
LAUDA Proline Master	S	-	-	Z	Z	Z	Z	Z	Z	Z	Z	2	-
LAUDA Proline Command	S	-	-	Z	S	Z	Z	Z	Z	Z	Z	2	-

S = Series standard

Z = Available as an accessory



LRZ 912
Analog module

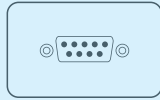

LRZ 913
RS 232/485 interface

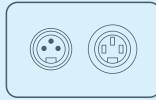

LRZ 914
Contact module with single input and single output (NAMUR)

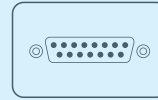

LRZ 915
Contact module with 3 inputs and 3 outputs

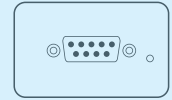

LRZ 917
Profibus module



LRZ 918
Pt100/Li bus module, small cover



LRZ 921
Ethernet module

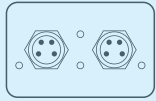

LRZ 922
EtherCAT module with M8 connection

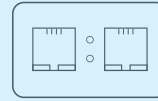

LRZ 923
EtherCAT module with RJ45 connection



LRZ 925
External Pt100/LiBus-module, large cover

LAUDA Proline bridge thermostat / Page 38

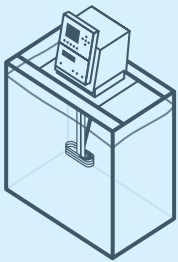

PB C
PBD C

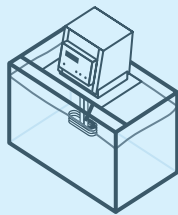

PB
PBD

LAUDA Proline clear-view thermostat / Page 40



PV 15 C
PVL 15 C

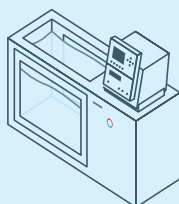

PV 24 C
PVL 24 C

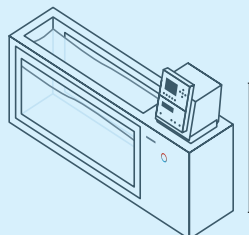

PV 36 C

646 mm



PV 15
PVL 15

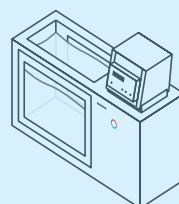

PV 24
PVL 24

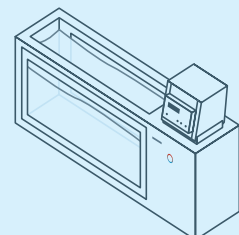

PV 36

646 mm

LAUDA Heating thermostats

Function overview

Operating element	Alpha	ECO S	ECO G	PRO Base	PRO Command Touch	Proline Master	Proline Command
Display	7-Segment	LCD mono	TFT	OLED	TFT	7-Segment	LCD mono
Mode of operation	3-button	3-button softkey	Cursor softkey	Cursor softkey	Multi-touch	4-button	Cursor softkey
Removable control	-	-	-	✓	✓	-	✓
User management	-	-	-	-	✓	-	-
Data logging, export to USB stick	-	-	-	-	✓	-	-
1-point calibration	✓	✓	✓	✓	✓	✓	✓
2-point calibration	-	-	-	✓	✓	-	-
Programmer, programs/segments	-	1 / 20	5 / 150	1 / 20	100 / 5000	-	5 / 150
Programmer, tolerance range function	-	✓	✓	✓	✓	-	✓
Ramp function	-	-	-	-	✓	-	✓
Timer function	-	-	-	-	✓	-	✓
Countdown function	✓	-	-	-	✓	-	✓
Graphic temperature profile display	-	-	✓	-	✓	-	✓
Adjustable bypass	-	-	-	-	-	✓	✓
Level indicator (digital)	-	-	-	✓	✓	✓	✓
Standby timer	-	✓	✓	✓	✓	✓	✓
Low-level alarm	✓	✓	✓	✓	✓	✓	✓
Drain tap	-	✓	✓	✓	✓	✓	✓
Drain screw	✓	-	-	-	-	-	-

LAUDA Heating thermostats

Technical data according to DIN 12876 standard

Device type	Working temperature range °C	Working temperature range with water cooling °C	Operating temperature range °C	Temperature stability ±K	Safety fittings	Heater power max. kW	Pump type	Pump pressure max. bar	Pump suction max. bar	Pump flow max. pressure L./min	Pump flow max. suction L./min	Pump connection thread mm	Nipples Øe	Bath volume min. L
LAUDA Alpha / Page 32														
A	25 ... 100	20 ... 100	-25 ... 100	0.05	I, NFL	1.5	D	0.2	-	15.0	-	N/A	-	-
A 6	25 ... 100	20 ... 100	-25 ... 100	0.05	I, NFL	1.5	D	0.2	-	15.0	-	N/A	-	2.5
A 12	25 ... 100	20 ... 100	-25 ... 100	0.05	I, NFL	1.5	D	0.2	-	15.0	-	N/A	-	8.0
A 24	25 ... 100	20 ... 100	-25 ... 100	0.05	I, NFL	1.5	D	0.2	-	15.0	-	N/A	-	18.0
LAUDA ECO / Page 34														
SILVER	20 ... 200	20 ... 200	-20 ... 200	0.01	III, FL	2.0	V	0.6	-	22.0	-	N/A	-	-
ET 6 S	20 ... 100	20 ... 100	-20 ... 100	0.01	III, FL	2.0	V	0.6	-	22.0	-	N/A	-	5.0
ET 12 S	20 ... 100	20 ... 100	-20 ... 100	0.01	III, FL	2.0	V	0.6	-	22.0	-	N/A	-	9.5
ET 15 S	20 ... 100	20 ... 100	-20 ... 100	0.01	III, FL	2.0	V	0.6	-	22.0	-	N/A	13	13.5
ET 20 S	20 ... 100	20 ... 100	-20 ... 100	0.01	III, FL	2.0	V	0.6	-	22.0	-	N/A	-	15.0
E 4 S	20 ... 200	20 ... 200	-20 ... 200	0.01	III, FL	2.0	V	0.6	-	22.0	-	N/A	13	3.0
E 10 S	20 ... 200	20 ... 200	-20 ... 200	0.01	III, FL	2.0	V	0.6	-	22.0	-	N/A	-	7.5
E 20 S	20 ... 200	20 ... 200	-20 ... 200	0.01	III, FL	2.0	V	0.6	-	22.0	-	N/A	-	13.0
E 25 S	20 ... 200	20 ... 200	-20 ... 200	0.01	III, FL	2.0	V	0.6	-	22.0	-	N/A	-	16.0
E 40 S	20 ... 200	20 ... 200	-20 ... 200	0.01	III, FL	2.0	V	0.6	-	22.0	-	N/A	-	32.0
GOLD	20 ... 200	20 ... 200	-20 ... 200	0.01	III, FL	2.6	V	0.6	-	22.0	-	N/A	-	-
ET 6 G	20 ... 100	20 ... 100	-20 ... 100	0.01	III, FL	2.6	V	0.6	-	22.0	-	N/A	-	5.0
ET 12 G	20 ... 100	20 ... 100	-20 ... 100	0.01	III, FL	2.6	V	0.6	-	22.0	-	N/A	-	9.5
ET 15 G	20 ... 100	20 ... 100	-20 ... 100	0.01	III, FL	2.6	V	0.6	-	22.0	-	M16×1	-	13.5
ET 20 G	20 ... 100	20 ... 100	-20 ... 100	0.01	III, FL	2.6	V	0.6	-	22.0	-	N/A	-	15.0
E 4 G	20 ... 200	20 ... 200	-20 ... 200	0.01	III, FL	2.6	V	0.6	-	22.0	-	M16×1	-	3.0
E 10 G	20 ... 200	20 ... 200	-20 ... 200	0.01	III, FL	2.6	V	0.6	-	22.0	-	N/A	-	7.5
E 20 G	20 ... 200	20 ... 200	-20 ... 200	0.01	III, FL	2.6	V	0.6	-	22.0	-	N/A	-	13.0
E 25 G	20 ... 200	20 ... 200	-20 ... 200	0.01	III, FL	2.6	V	0.6	-	22.0	-	N/A	-	16.0
E 40 G	20 ... 200	20 ... 200	-20 ... 200	0.01	III, FL	2.6	V	0.6	-	22.0	-	N/A	-	32.0

Bath volume max. L	Bath opening (W x D) mm	Bath depth mm	Usable depth mm	Height top of bath mm	Dimensions (W x D x H) mm	Weight kg	Power supply V; Hz	Loading max. kW	Cat. No.	Device type
50.0	-	150	100	-	125×150×300	3.5	230 V; 50/60 Hz	1.5	L000618	A
5.5	145×161	150	130	212	181×332×370	6.2	230 V; 50/60 Hz	1.5	L000619	A 6
12.0	235×161	200	180	262	270×332×420	7.5	230 V; 50/60 Hz	1.5	L000620	A 12
25.0	295×374	200	180	262	332×535×420	10.5	230 V; 50/60 Hz	1.5	L000621	A 24
-	-	150	-	-	130×135×325	3.0	230 V; 50/60 Hz	2.1	L001076	SILVER
6.0	130×285	160	140	169	143×433×349	4.1	230 V; 50/60 Hz	2.1	L001096	ET 6 S
12.0	300×175	160	140	208	322×331×389	6.4	230 V; 50/60 Hz	2.1	L001097	ET 12 S
15.0	275×130	310	290	356	428×148×532	6.4	230 V; 50/60 Hz	2.1	L001098	ET 15 S
20.0	300×350	160	140	208	322×506×389	7.6	230 V; 50/60 Hz	2.1	L001099	ET 20 S
3.5	135×105	150	130	196	168×272×376	6.6	230 V; 50/60 Hz	2.1	L001084	E 4 S
11.0	300×190	150	130	196	331×361×376	8.6	230 V; 50/60 Hz	2.1	L001085	E 10 S
19.0	300×365	150	130	196	331×537×376	11.8	230 V; 50/60 Hz	2.1	L001087	E 20 S
25.0	300×365	200	180	246	331×537×426	13.1	230 V; 50/60 Hz	2.1	L001088	E 25 S
40.0	300×613	200	180	248	350×803×428	17.2	230 V; 50/60 Hz	2.1	L001089	E 40 S
-	-	150	-	-	130×135×325	3.4	230 V; 50/60 Hz	2.7	L001077	GOLD
6.0	130×285	160	140	169	143×433×349	4.5	230 V; 50/60 Hz	2.7	L001100	ET 6 G
12.0	300×175	160	140	208	322×331×389	6.8	230 V; 50/60 Hz	2.7	L001101	ET 12 G
15.0	275×130	310	290	356	428×148×532	6.8	230 V; 50/60 Hz	2.7	L001102	ET 15 G
20.0	300×350	160	140	208	322×506×389	8.0	230 V; 50/60 Hz	2.7	L001103	ET 20 G
3.5	135×105	150	130	196	168×272×376	7.0	230 V; 50/60 Hz	2.7	L001090	E 4 G
11.0	300×190	150	130	196	331×361×376	9.0	230 V; 50/60 Hz	2.7	L001091	E 10 G
19.0	300×365	150	130	196	331×537×376	12.2	230 V; 50/60 Hz	2.7	L001093	E 20 G
25.0	300×365	200	180	246	331×537×426	13.5	230 V; 50/60 Hz	2.7	L001094	E 25 G
40.0	300×613	200	180	248	350×803×428	17.6	230 V; 50/60 Hz	2.7	L001095	E 40 G

LAUDA Heating thermostats

Technical data according to DIN 12876 standard

Device type	Working temperature range °C	Working temperature range with water cooling °C	Operating temperature range °C	Temperature stability ±K	Safety fittings	Heater power max. kW	Pump type	Pump pressure max. bar	Pump suction max. bar	Pump flow max. pressure L./min	Pump flow max. suction L./min	Pump connection thread mm	Nipples Øe	Bath volume min. L
-------------	------------------------------	---	--------------------------------	--------------------------	-----------------	----------------------	-----------	------------------------	-----------------------	--------------------------------	-------------------------------	---------------------------	------------	--------------------

LAUDA PRO / Page 36

P 10	40 ... 250	20 ... 250	-30 ... 250	0.01	III, FL	3.6	V	-	-	-	-	N/A	-	5.0
P 20	35 ... 250	20 ... 250	-30 ... 250	0.01	III, FL	3.6	V	-	-	-	-	N/A	-	11.0
P 30	30 ... 250	20 ... 250	-30 ... 250	0.01	III, FL	3.6	V	-	-	-	-	N/A	-	15.0
P 10 C	40 ... 250	20 ... 250	-30 ... 250	0.01	III, FL	3.6	V	-	-	-	-	N/A	-	5.0
P 20 C	35 ... 250	20 ... 250	-30 ... 250	0.01	III, FL	3.6	V	-	-	-	-	N/A	-	11.0
P 30 C	30 ... 250	20 ... 250	-30 ... 250	0.01	III, FL	3.6	V	-	-	-	-	N/A	-	15.0

LAUDA Proline Bridge thermostat / Page 38

PB	30 ... 300	20 ... 300	-30 ... 300	0.01	III, FL	3.6	VF	0.7	0.4	25.0	23	M16×1	13	0.0
PBD	30 ... 300	20 ... 300	-30 ... 300	0.01	III, FL	3.6	V	1.1	-	32.0	-	M16×1	13	0.0
PB C	30 ... 300	20 ... 300	-30 ... 300	0.01	III, FL	3.6	VF	0.7	0.4	25.0	23	M16×1	13	0.0
PBDC	30 ... 300	20 ... 300	-30 ... 300	0.01	III, FL	3.6	V	1.1	-	32.0	-	M16×1	13	0.0

LAUDA Proline Clear-view thermostat / Page 40

PV 15	30 ... 230	20 ... 230	0 ... 230	0.01	III, FL	3.6	V	0.8	-	25.0	-	M16×1	13	11.0
PV 24	30 ... 230	20 ... 230	0 ... 230	0.01	III, FL	3.6	V	0.8	-	25.0	-	M16×1	13	19.0
PV 36	30 ... 230	20 ... 230	0 ... 230	0.01	III, FL	3.6	V	0.8	-	25.0	-	M16×1	13	28.0
PVL 15	30 ... 100	20 ... 100	-60 ... 100	0.01	III, FL	3.6	V	0.8	-	25.0	-	M16×1	13	11.0
PVL 24	30 ... 100	20 ... 100	-60 ... 100	0.01	III, FL	3.6	V	0.8	-	25.0	-	M16×1	13	19.0
PV 15 C	30 ... 230	20 ... 230	0 ... 230	0.01	III, FL	3.6	V	0.8	-	25.0	-	M16×1	13	11.0
PV 24 C	30 ... 230	20 ... 230	0 ... 230	0.01	III, FL	3.6	V	0.8	-	25.0	-	M16×1	13	19.0
PV 36 C	30 ... 230	20 ... 230	0 ... 230	0.01	III, FL	3.6	V	0.8	-	25.0	-	M16×1	13	28.0
PVL 15 C	30 ... 100	20 ... 100	-60 ... 100	0.01	III, FL	3.6	V	0.8	-	25.0	-	M16×1	13	11.0
PVL 24 C	30 ... 100	20 ... 100	-60 ... 100	0.01	III, FL	3.6	V	0.8	-	25.0	-	M16×1	13	19.0

Bath volume max. L	Bath opening (W x D) mm	Bath depth mm	Usable depth mm	Height top of bath mm	Dimensions (W x D x H) mm	Weight kg	Power supply V; Hz	Loading max. kW	Cat. No.	Device type
10.0	240×150	200	180	250	310×335×365	13.5	200-230 V; 50/60 Hz	3.7	L000001	P 10
20.0	300×290	200	180	250	350×475×365	17.0	200-230 V; 50/60 Hz	3.7	L000002	P 20
28.5	340×385	200	180	250	400×600×365	23.0	200-230 V; 50/60 Hz	3.7	L000003	P 30
10.0	240×150	200	180	250	310×335×415	13.5	200-230 V; 50/60 Hz	3.7	L000004	P 10 C
20.0	300×290	200	180	250	350×475×415	17.0	200-230 V; 50/60 Hz	3.7	L000005	P 20 C
28.5	340×385	200	180	250	400×600×415	23.0	200-230 V; 50/60 Hz	3.7	L000006	P 30 C
80.0	-	-	-	-	320×185×400	8.0	230 V; 50/60 Hz	3.7	L001542	PB
80.0	-	-	-	-	320×185×400	8.0	230 V; 50/60 Hz	3.7	L001544	PBD
80.0	-	-	-	-	320×185×576	8.0	230 V; 50/60 Hz	3.7	L001543	PB C
80.0	-	-	-	-	320×185×576	8.0	230 V; 50/60 Hz	3.7	L001545	PBD C
15.0	230×135	320	285	390	506×282×590	26.0	230 V; 50/60 Hz	3.7	L001532	PV 15
24.0	405×135	320	285	390	740×282×590	36.0	230 V; 50/60 Hz	3.7	L001533	PV 24
36.0	585×135	320	285	390	1040×282×590	44.0	230 V; 50/60 Hz	3.7	L001534	PV 36
15.0	230×135	320	285	390	506×282×590	28.0	230 V; 50/60 Hz	3.7	L001538	PVL 15
24.0	405×135	320	285	390	740×282×590	39.0	230 V; 50/60 Hz	3.7	L001539	PVL 24
15.0	230×135	320	285	390	506×282×646	26.0	230 V; 50/60 Hz	3.7	L001535	PV 15 C
24.0	405×135	320	285	390	740×282×646	36.0	230 V; 50/60 Hz	3.7	L001536	PV 24 C
36.0	585×135	320	285	390	1040×282×646	44.0	230 V; 50/60 Hz	3.7	L001537	PV 36 C
15.0	230×135	320	285	390	506×282×646	28.0	230 V; 50/60 Hz	3.7	L001540	PVL 15 C
24.0	405×135	320	285	390	740×282×646	39.0	230 V; 50/60 Hz	3.7	L001541	PVL 24 C

LAUDA Heating thermostats

Power supply variants

Device type	Power supply V; Hz	Heater power max. kW	Loading max. kW	Plug code*	Cat. No.	Device type	Power supply V; Hz	Heater power max. kW	Loading max. kW	Plug code*	Cat. No.
LAUDA Alpha / Page 32											
A	100 V; 50/60 Hz	1.0	1.0	14	L000634	A 12	100 V; 50/60 Hz	1.0	1.0	14	L000636
A	115 V; 60 Hz	1.2	1.2	14	L000630	A 12	115 V; 60 Hz	1.2	1.2	14	L000632
A 6	100 V; 50/60 Hz	1.0	1.0	14	L000635	A 24	100 V; 50/60 Hz	1.0	1.0	14	L000637
A 6	115 V; 60 Hz	1.2	1.2	14	L000631	A 24	115 V; 60 Hz	1.2	1.2	14	L000633
LAUDA ECO / Page 34											
SILVER	100 V; 50/60 Hz	1.0	1.1	14	L001082	E 40 S	100 V; 50/60 Hz	1.0	1.1	14	L001225
SILVER	115 V; 60 Hz	1.3	1.4	14	L001080	E 40 S	115 V; 60 Hz	1.3	1.4	14	L001196
SILVER	220 V; 60 Hz	1.9	2.0	3	L001078	E 40 S	220 V; 60 Hz	1.8	2.1	3	L001176
ET 6 S	100 V; 50/60 Hz	1.0	1.1	14	L001232	GOLD	100 V; 50/60 Hz	1.0	1.1	14	L001083
ET 6 S	115 V; 60 Hz	1.3	1.4	14	L001203	GOLD	115 V; 60 Hz	1.3	1.4	14	L001081
ET 6 S	220 V; 60 Hz	1.8	2.0	3	L001183	GOLD	220 V; 60 Hz	2.4	2.5	3	L001079
ET 12 S	100 V; 50/60 Hz	1.0	1.1	14	L001233	ET 6 G	100 V; 50/60 Hz	1.0	1.1	14	L001236
ET 12 S	115 V; 60 Hz	1.3	1.4	14	L001204	ET 6 G	115 V; 60 Hz	1.3	1.4	14	L001207
ET 12 S	220 V; 60 Hz	1.8	2.7	3	L001184	ET 6 G	220 V; 60 Hz	2.4	2.5	3	L001187
ET 15 S	100 V; 50/60 Hz	1.0	1.1	14	L001234	ET 12 G	100 V; 50/60 Hz	1.0	1.1	14	L001237
ET 15 S	115 V; 60 Hz	1.3	1.4	14	L001205	ET 12 G	115 V; 60 Hz	1.3	1.4	14	L001208
ET 15 S	220 V; 60 Hz	1.8	2.7	3	L001185	ET 12 G	220 V; 60 Hz	2.4	2.5	3	L001188
ET 20 S	100 V; 50/60 Hz	1.0	1.1	14	L001235	ET 15 G	100 V; 50/60 Hz	1.0	1.1	14	L001238
ET 20 S	115 V; 60 Hz	1.3	1.4	14	L001206	ET 15 G	115 V; 60 Hz	1.3	1.4	14	L001209
ET 20 S	220 V; 60 Hz	1.8	2.7	3	L001186	ET 15 G	220 V; 60 Hz	2.4	2.5	3	L001189
E 4 S	100 V; 50/60 Hz	1.0	1.1	14	L001220	ET 20 G	100 V; 50/60 Hz	1.0	1.1	14	L001239
E 4 S	115 V; 60 Hz	1.3	1.4	14	L001191	ET 20 G	115 V; 60 Hz	1.3	1.4	14	L001210
E 4 S	220 V; 60 Hz	1.8	2.1	3	L001171	ET 20 G	220 V; 60 Hz	2.4	2.5	3	L001190
E 10 S	100 V; 50/60 Hz	1.0	1.1	14	L001221	E 4 G	100 V; 50/60 Hz	1.0	1.1	14	L001226
E 10 S	115 V; 60 Hz	1.3	1.4	14	L001192	E 4 G	115 V; 60 Hz	1.3	1.4	14	L001197
E 10 S	220 V; 60 Hz	1.8	2.1	3	L001172	E 4 G	220 V; 60 Hz	2.4	2.5	3	L001177
E 20 S	100 V; 50/60 Hz	1.0	1.1	14	L001223	E 10 G	100 V; 50/60 Hz	1.0	1.1	14	L001227
E 20 S	115 V; 60 Hz	1.3	1.4	14	L001194	E 10 G	115 V; 60 Hz	1.3	1.4	14	L001198
E 20 S	220 V; 60 Hz	1.8	2.1	3	L001174	E 10 G	220 V; 60 Hz	2.4	2.5	3	L001178
E 25 S	100 V; 50/60 Hz	1.0	1.1	14	L001224	E 10 G	100 V; 50/60 Hz	1.0	1.1	14	L001227
E 25 S	115 V; 60 Hz	1.3	1.4	14	L001195	E 10 G	115 V; 60 Hz	1.3	1.4	14	L001198
E 25 S	220 V; 60 Hz	1.8	2.1	3	L001175	E 10 G	220 V; 60 Hz	2.4	2.5	3	L001178

Device type	Power supply V; Hz	Heater power max. kW	Loading max. kW	Plug code*	Cat. No.	Device type	Power supply V; Hz	Heater power max. kW	Loading max. kW	Plug code*	Cat. No.
LAUDA ECO / Page 34											
E 20 G	100 V; 50/60 Hz	1.0	1.1	14	L001229	E 40 G	100 V; 50/60 Hz	1.0	1.1	14	L001231
E 20 G	115 V; 60 Hz	1.3	1.4	14	L001200	E 40 G	115 V; 60 Hz	1.3	1.4	14	L001202
E 20 G	220 V; 60 Hz	2.4	2.5	3	L001180	E 40 G	220 V; 60 Hz	2.4	2.5	3	L001182
E 25 G	100 V; 50/60 Hz	1.0	1.1	14	L001230						
E 25 G	115 V; 60 Hz	1.3	1.4	14	L001201						
E 25 G	220 V; 60 Hz	2.4	2.5	3	L001181						
LAUDA PRO / Page 36											
P 10	100-120 V; 50/60 Hz	1.9	1.9	32	L000554	P 10 C	100-120 V; 50/60 Hz	1.9	1.9	4	L000550
P 10	100-120 V; 50/60 Hz	1.9	1.9	4	L000546	P 10 C	100-120 V; 50/60 Hz	1.9	1.9	32	L000558
P 20	100-120 V; 50/60 Hz	1.9	1.9	4	L000547	P 20 C	100-120 V; 50/60 Hz	1.9	1.9	32	L000559
P 20	100-120 V; 50/60 Hz	1.9	1.9	32	L000555	P 20 C	100-120 V; 50/60 Hz	1.9	1.9	4	L000551
P 30	100-120 V; 50/60 Hz	1.9	1.9	4	L000548	P 30 C	100-120 V; 50/60 Hz	1.9	1.9	32	L000560
P 30	100-120 V; 50/60 Hz	1.9	1.9	32	L000556	P 30 C	100-120 V; 50/60 Hz	1.9	1.9	4	L000552
LAUDA Proline Bridge thermostat / Page 38											
PB	100 V; 50/60 Hz	1.3	1.5	4	L001590	PBC	100 V; 50/60 Hz	1.3	1.5	4	L001591
PB	115 V; 60 Hz	1.7	1.9	4	L001580	PBC	115 V; 60 Hz	1.7	1.9	4	L001581
PBD	100 V; 50/60 Hz	1.3	1.5	4	L001592	PBD C	100 V; 50/60 Hz	1.3	1.5	4	L001593
PBD	115 V; 60 Hz	1.7	1.9	4	L001582	PBD C	115 V; 60 Hz	1.7	1.9	4	L001583
LAUDA Proline Clear-view thermostat / Page 40											
PV 15	100 V; 50/60 Hz	1.3	1.5	4	L001584	PV 15 C	100 V; 50/60 Hz	1.3	1.5	4	L001585
PV 15	115 V; 60 Hz	1.7	1.9	4	L001574	PV 15 C	115 V; 60 Hz	1.7	1.9	4	L001575
PV 24	200 V; 50/60 Hz	2.7	2.9	3	L001594	PV 24 C	200 V; 50/60 Hz	2.7	2.9	3	L001596
PV 24	208-220 V; 60 Hz	3.3	3.5	3	L001598	PV 24 C	208-220 V; 60 Hz	3.3	3.5	3	L001600
PV 36	200 V; 50/60 Hz	2.7	2.9	3	L001595	PV 36 C	200 V; 50/60 Hz	2.7	2.9	3	L001597
PV 36	208-220 V; 60 Hz	3.3	3.5	3	L001599	PV 36 C	208-220 V; 60 Hz	3.3	3.5	3	L001601
PVL 15	100 V; 50/60 Hz	1.3	1.5	4	L001586	PVL 15 C	100 V; 50/60 Hz	1.3	1.5	4	L001588
PVL 15	115 V; 60 Hz	1.7	1.9	4	L001576	PVL 15 C	115 V; 60 Hz	1.7	1.9	4	L001578
PVL 24	100 V; 50/60 Hz	1.3	1.5	4	L001587	PVL 24 C	100 V; 50/60 Hz	1.3	1.5	4	L001589
PVL 24	115 V; 60 Hz	1.7	1.9	4	L001577	PVL 24 C	115 V; 60 Hz	1.7	1.9	4	L001579

*All data for the plug codes can be found on page 150

LAUDA Heating thermostats

More characteristics

LAUDA Alpha / Page 32

PUMP CHARACTERISTIC Water

Pressure bar

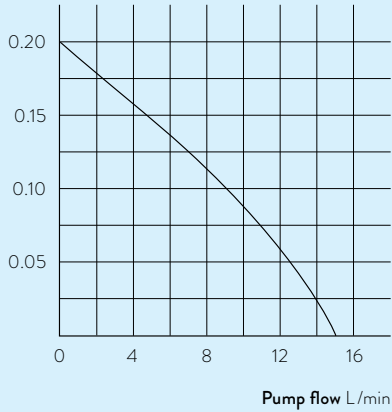

LAUDA ECO / Page 34

HEATING PERFORMANCE Heat transfer liquid: Therm 240, bath closed

Bath temperature °C

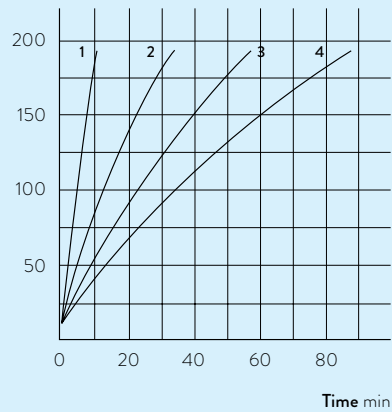

- 1 E 4 S
- 2 E 10 S
- 3 E 20 S
- 4 E 25 S

HEATING PERFORMANCE Heat transfer liquid: Water, bath closed

Bath temperature °C

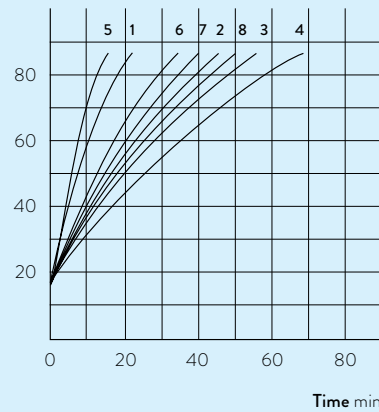

- 1 ET 6 S
- 2 ET 12 S
- 3 ET 15 S
- 4 ET 20 S
- 5 ET 6 G
- 6 ET 12 G
- 7 ET 15 G
- 8 ET 20 G

PUMP CHARACTERISTIC Water

Pressure bar

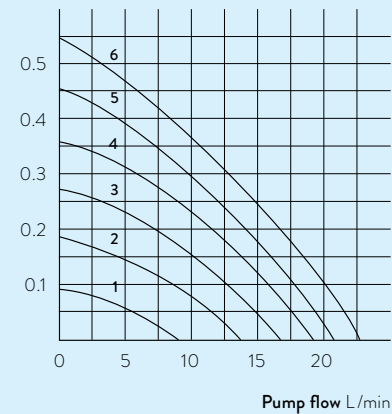

- 1 Step 1
- 2 Step 2
- 3 Step 3
- 4 Step 4
- 5 Step 5
- 6 Step 6

PUMP CHARACTERISTIC for PB and PBC, Water

Pressure bar

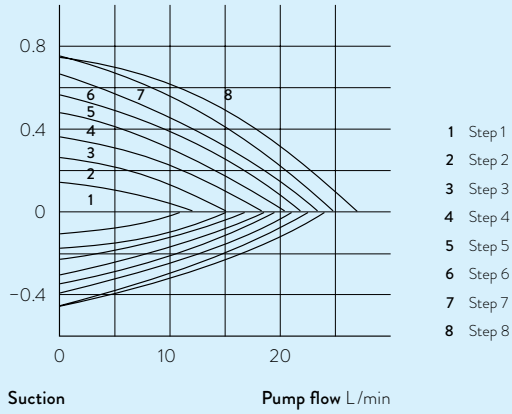

PUMP CHARACTERISTIC for PBD and PBD C, Water

Pressure bar

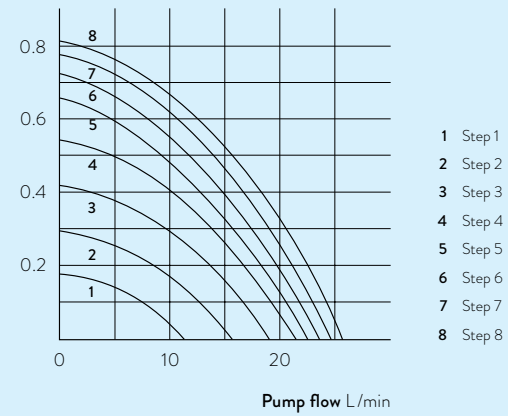

LAUDA

COOLING THERMOSTATS

°LAUDA



Specific application examples

- Sample preparation in chemistry and pharmacy
- Functional testing of electronic components
- Test of slide bearings
- Beer forcing test
- Valve testing
- Stress test
- Notch bending test
- Expansion testing
- Brookfield test
- Semi-conductor coating



LAUDA Alpha

Affordable cooling thermostats for maintaining temperatures from -25 to 100 °C in the lab

-25 °C  100 °C

The cost-efficient choice for high-quality LAUDA thermostats

LAUDA Alpha offers reliable technology for temperature ranges from -25 to 100 °C. This line of devices is suitable for internal and external temperature control thermostating with non-flammable liquids (water and water/glycol). The thermostats are the perfect solution for most basic temperature control applications in the lab. Optimized down to the most essential functions, this affordable product line will win you over with its reliability and user-friendliness.



Cost savings through automatic compressor control: Cooling capacity is only provided when it is needed



Easy cleaning of the cooling air inlet enabled by simple removal of front cover without tools

COOLING PERFORMANCE Heat transfer liquid: Ethanol, bath closed

Bath temperature °C

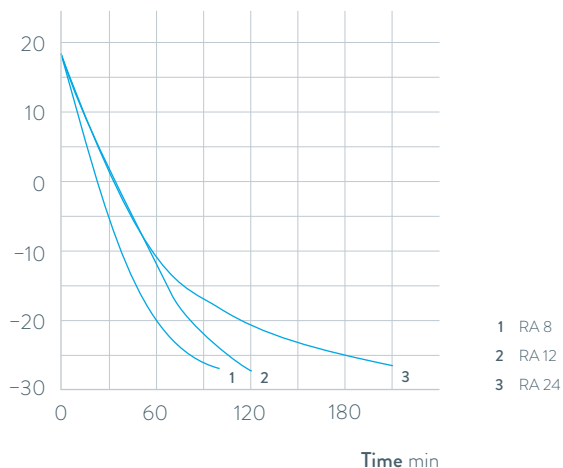

Important functions

- Stainless steel bath vessels
- Drain connection at the rear

Included accessories

Pump circulation set, bath cover, pump link for pump connections

Further accessories

Racks, tubing

All technical data and power supply variants can be found in the ›Technical data‹ section.

More at www.lauda.de/1736



LAUDA Alpha

The cooling thermostats RA 8, RA 12 and RA 24, including standard-issue bath covers and pump connections, facilitate cooling across the entire temperature range from -25 to 100 °C. Automatic compressor control extends the service life of the compressor and offers savings on operation costs.



LAUDA ECO

From -50 to 200 °C: Cooling thermostats for economic temperature control in the lab



Impressive range of capabilities coupled with easy operation

The ECO thermostats are available in standard Silver (LCD) or Gold (color TFT display) models equipped with a mini USB interface. The circulation pump can be adjusted to six levels. The comprehensive model portfolio offers devices with cooling capacities of 180 to 700 watts and minimum temperatures of -15 to -50 °C. The devices of the LAUDA ECO series with the highest performance work with an energy-saving LAUDA SmartCool system which automatically adjusts the cooling capacity to the required operating condition.



Plain text menu guidance on a monochrome LCD (Silver) or color TFT display (Gold) for easy and intuitive operation



Standard pump connections for temperature control of external applications

COOLING PERFORMANCE Heat transfer liquid: Ethanol, bath closed

Bath temperature °C

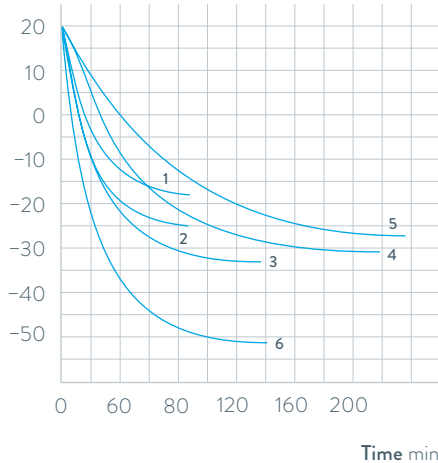

- 1 RE 415 G
- 2 RE 420 G
- 3 RE 630 G
- 4 RE 1225 G
- 5 RE 2025 G
- 6 RE 1050 G

Important functions

- Integrated programmer for automating temperature profiles
- Adjustment of flow rate switch for internal/external circulation, can be actuated from exterior during operation
- USB interface as standard

Included accessories

Bath cover, pump connections, closing plugs

Further accessories

Tubing, interface modules

All technical data and power supply variants can be found in the ›Technical data‹ section.

More at www.lauda.de/1738



LAUDA ECO

The cooling thermostats come with a bath cover and pump connections as standard. A drain tap on the back side of the device makes changing the heat transfer liquid easy and safe.



LAUDA PRO

Cooling bath thermostats for professional temperature control from -100 to 200 °C



Flexible operation, outstanding performance

With LAUDA PRO, customers gain access to a cutting-edge product line with an outstanding overall concept. There are two operating units available: Base or Command Touch. These can be removed from the thermostat for very high levels of flexibility. On the one hand, this permits remote control of the devices and on the other hand, this considerably reduces the height of the devices. In addition, they are also equipped with a hybrid cooling system as standard. This enables additional cooling of the refrigerating machine with water.



Low device height and 360° accessibility of the bath thanks to detachable remote control

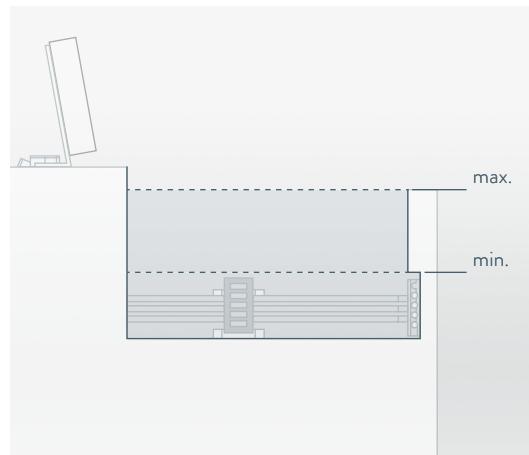

Full functionality of the bath with low minimum fill height

COOLING PERFORMANCE Heat transfer liquid: Ethanol, bath closed

Bath temperature °C

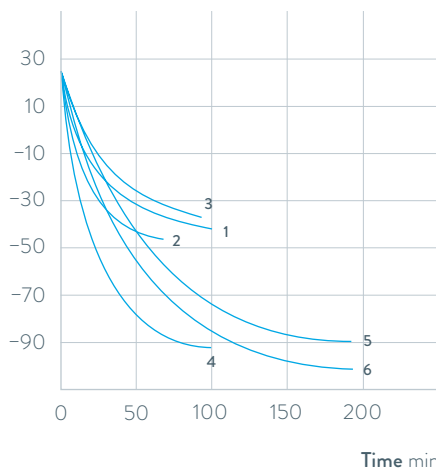

- 1 RP 2040 C
- 2 RP 2045 C
- 3 RP 3035 C
- 4 RP 1090 C
- 5 RP 2090 C
- 6 RP 10100 C

Important functions

- Internal LAUDA Vario Pump with 8 selectable output levels
- Hybrid cooling of the refrigerating machine permits cooling using ambient air or, in addition, using cooling water
- Standard bath edge heating on all types prevents the formation of ice on the surface of the bath cover

Included accessories

Bath cover, tubing nipples with screw caps for the cooling coil

Further accessories

External pump, interface modules

All technical data and power supply variants can be found in the [Technical data](#) section.

More at www.lauda.de/1740



LAUDA PRO

The PRO cooling bath thermostats for internal bath applications offer a working temperature range from -100 to 200 °C. An incrementally adjustable pump ensures excellent homogeneity of the bath. With their bath sizes from 10 to 30 liters and cooling capacity from 0.4 to 1.5 kW, the thermostats are suitable for a wide range of applications.



LAUDA Proline Kryomats

High-performance cooling thermostats from -90 to 200°C for use in process technology and material testing



High cooling performance and compact design

The Proline Kryomats are cooling thermostats that feature the latest technology with high efficiency and an excellent price-performance ratio. The pressure pump is optimized for internal circulation and can be set to four levels – the standard-issue LAUDA Command remote control also makes it especially user-friendly. Furthermore, integrated bath edge and bath bridge heating prevent the formation of condensation caused by air humidity at low temperatures.



Optimal circulation and temperature distribution throughout the entire bath thanks to an adjustable pump nozzle



Spacious baths and large bath openings – ideal for bulky test specimens and effective throughput

COOLING PERFORMANCE Heat transfer liquid: Ethanol, bath closed

Bath temperature $^{\circ}\text{C}$

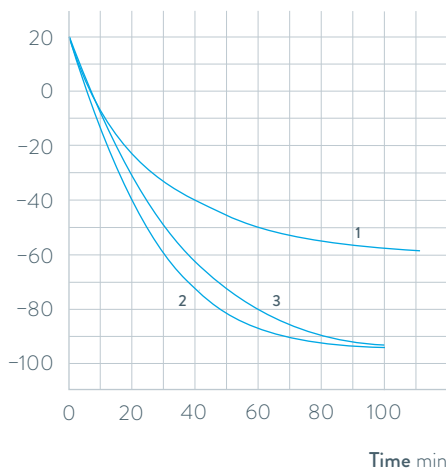

- 1 RP 4050 C
- 2 RP 3090 C
- 3 RP 4090 C

Important functions

- Removable Command operating unit with high-resolution, graphic LCD screen and individually selectable display functions
- Programmer with 150 temperature/time segments, can be divided into 5 programs
- Pump connections on side and rear, integrated bypass

Included accessories

Bath cover, tubing nipples

Further accessories

Inset baskets, interface modules

All technical data and power supply variants can be found in the [Technical data](#) section.

More at www.lauda.de/1742



LAUDA Proline Kryomats

The air and water-cooled versions of the Proline Kryomats are available with large bath openings and volumes of 30 and 40 liters.



LAUDA Cooling thermostats

Device type overview

LAUDA Alpha / Page 56

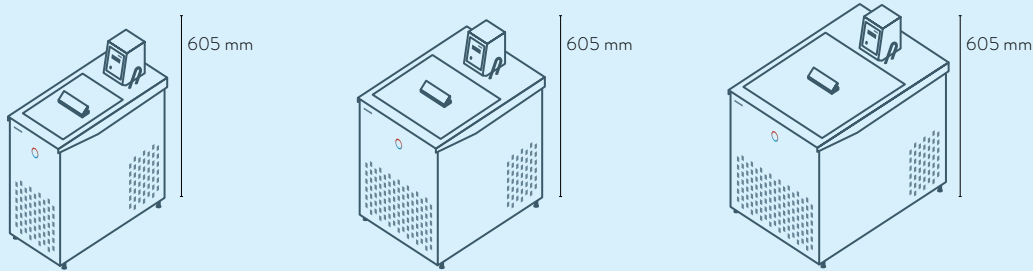

RA 8

RA 12

RA 24

LAUDA ECO / Page 58

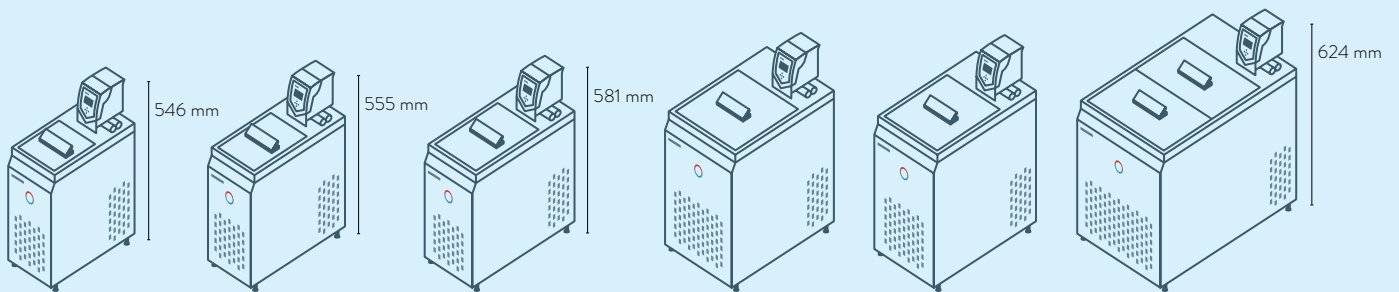

RE 415 G

RE 420 G

RE 630 G

RE 1050 G

RE 1225 G

RE 2025 G

LAUDA PRO / Page 60

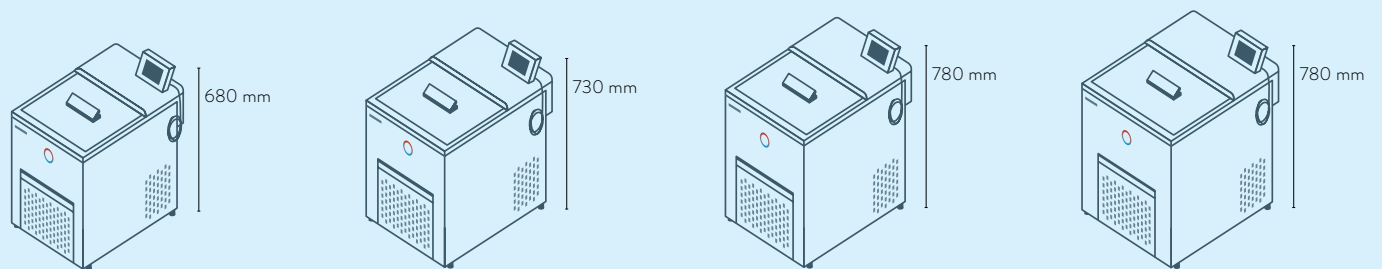

RP 2040 C
RP 2045 C

RP 3035 C

RP 1090 C

RP 2090 C
RP 10100 C

LAUDA Proline Kryomats / Page 62

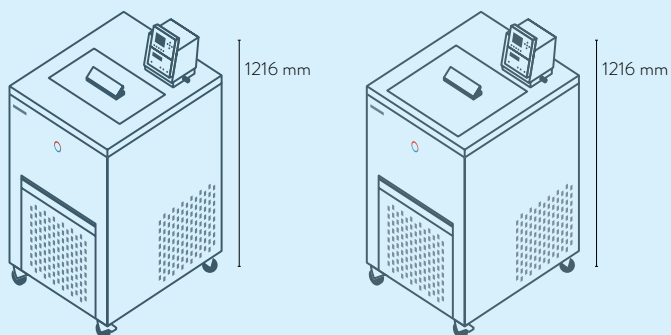

RP 3090 C / CW

RP 4090 C / CW

LAUDA Cooling thermostats

Interfaces

	Pt 100 (1)	Pt 100 (2)	USB	Ethernet	RS 232 / 485	Analog	Namur contact	Sub-D contact	Profibus	EtherCat M8	EtherCat RJ 45	Number of module slots, large	Number of module slots, small
LAUDA Alpha / Page 56	-	-	-	-	-	-	-	-	-	-	-	-	-
LAUDA ECO / Page 58	Z	-	S	Z	Z	Z	Z	Z	Z	Z	Z	1	1
LAUDA PRO / Page 60	S	-	S	S	Z	Z	Z	Z	Z	Z	Z	1	-
LAUDA Proline Kryomat / Page 62	S	-	-	Z	S	Z	Z	Z	Z	Z	Z	2	-

S = Series standard

Z = Available as an accessory



LRZ 912
Analog module



LRZ 913
RS 232/485
interface



LRZ 914
Contact module with single input
and single output (NAMUR)



LRZ 915
Contact module with
3 inputs and 3 outputs



LRZ 917
Profibus module



LRZ 918
Pt100/Li bus module,
small cover



LRZ 921
Ethernet module



LRZ 922
EtherCAT module
with M8 connection

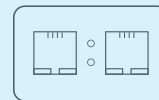

LRZ 923
EtherCAT module
with RJ45 connection



LRZ 925
External Pt100/LiBus-
module, large cover

LAUDA Cooling thermostats

Function overview

Operating element	Alpha	ECO S	ECO G	PRO Base	PRO Command Touch	Proline Kryomats
Display	7-Segment	LCD mono	TFT	OLED	TFT	LCD mono
Mode of operation	3-button	3-button softkey	Cursor softkey	Cursor softkey	Multi-touch	Cursor softkey
Removable control	-	-	-	✓	✓	✓
User management	-	-	-	-	✓	-
Data logging, export to USB stick	-	-	-	-	✓	-
1-point calibration	✓	✓	✓	✓	✓	✓
2-point calibration	-	-	-	✓	✓	-
Programmer, programs/segments	-	1 / 20	5 / 150	1 / 20	100 / 5000	5 / 150
Programmer, tolerance range function	-	✓	✓	✓	✓	✓
Ramp function	-	-	-	-	✓	✓
Timer function	-	-	-	-	✓	✓
Countdown function	✓	-	-	-	✓	✓
Graphic temperature profile display	-	-	✓	-	✓	✓
Adjustable bypass	-	-	-	-	-	✓
Level indicator (digital)	-	-	-	✓	✓	✓
Standby timer	-	✓	✓	✓	✓	✓
Low-level alarm	✓	✓	✓	✓	✓	✓
Drain tap	-	✓	✓	✓	✓	✓
Drain screw	✓	-	-	-	-	-

LAUDA Cooling thermostats

Technical data according to DIN 12876 standard

Device type	Working temperature range °C	Temperature stability ±K	Safety fittings	Heater power max. kW	Cooling output kW														Pump type	Pump pressure max. bar
					20 °C	10 °C	0 °C	-10 °C	-20 °C	-25 °C	-30 °C	-40 °C	-50 °C	-60 °C	-70 °C	-80 °C	-90 °C	-100 °C		
LAUDA Alpha / Page 56																				
RA 8	-25 ... 100	0.05	I, NFL	1.5	0.23	-	0.16	-	0.08	-	-	-	-	-	-	-	-	D	0.2	
RA 12	-25 ... 100	0.05	I, NFL	1.5	0.33	-	0.26	-	0.08	-	-	-	-	-	-	-	-	D	0.2	
RA 24	-25 ... 100	0.05	I, NFL	1.5	0.43	-	0.33	-	0.08	-	-	-	-	-	-	-	-	D	0.2	
LAUDA ECO / Page 58																				
RE 415 S	-15 ... 200	0.02	III, FL	2.0	0.18 ¹	-	0.12 ¹	-	-	-	-	-	-	-	-	-	-	V	0.6	
RE 420 S	-20 ... 200	0.02	III, FL	2.0	0.20 ¹	-	0.15 ¹	-	0.03 ¹	-	-	-	-	-	-	-	-	V	0.6	
RE 630 S	-30 ... 200	0.02	III, FL	2.0	0.30 ¹	-	0.24 ¹	-	0.10 ¹	-	0.02 ¹	-	-	-	-	-	-	V	0.6	
RE 1050 S	-50 ... 200	0.02	III, FL	2.0	0.70 ¹	-	0.60 ¹	-	0.35 ¹	-	0.19 ¹	0.10 ¹	0.02 ¹	-	-	-	-	V	0.6	
RE 1225 S	-25 ... 200	0.02	III, FL	2.0	0.30 ¹	-	0.24 ¹	-	0.09 ¹	0.04 ¹	-	-	-	-	-	-	-	V	0.6	
RE 2025 S	-25 ... 200	0.02	III, FL	2.0	0.30 ¹	-	0.23 ¹	-	0.06 ¹	0.03 ¹	-	-	-	-	-	-	-	V	0.6	
RE 415 G	-15 ... 200	0.02	III, FL	2.6	0.18 ¹	-	0.12 ¹	-	-	-	-	-	-	-	-	-	-	V	0.6	
RE 420 G	-20 ... 200	0.02	III, FL	2.6	0.20 ¹	-	0.15 ¹	-	0.03 ¹	-	-	-	-	-	-	-	-	V	0.6	
RE 630 G	-30 ... 200	0.02	III, FL	2.6	0.30 ¹	-	0.24 ¹	-	0.10 ¹	-	0.02 ¹	-	-	-	-	-	-	V	0.6	
RE 1050 G	-50 ... 200	0.02	III, FL	2.6	0.70 ¹	-	0.60 ¹	-	0.35 ¹	-	0.19 ¹	0.10 ¹	0.02 ¹	-	-	-	-	V	0.6	
RE 1225 G	-25 ... 200	0.02	III, FL	2.6	0.30 ¹	-	0.24 ¹	-	0.09 ¹	0.04 ¹	-	-	-	-	-	-	-	V	0.6	
RE 2025 G	-25 ... 200	0.02	III, FL	2.6	0.30 ¹	-	0.23 ¹	-	0.06 ¹	0.03 ¹	-	-	-	-	-	-	-	V	0.6	

¹Pump output step 2

Pump flow max. pressure L/min	Pump connection thread mm	Nipples Øe	Bath volume min. L	Bath volume max. L	Bath opening (W x D) mm	Bath depth mm	Usable depth mm	Height top of bath mm	Dimensions (W x D x H) mm	Weight kg	Power supply V; Hz	Loading max. kW	Cat. No.	Device type
15.0	N/A	13	5.0	7.5	165×177	160	140	450	235×500×605	31.0	230 V; 50 Hz	1.8	L000638	RA 8
15.0	N/A	13	9.5	14.5	300×203	160	140	450	365×500×605	37.0	230 V; 50 Hz	1.8	L000639	RA 12
15.0	N/A	13	14.0	22.0	350×277	160	140	450	415×605×605	43.0	230 V; 50 Hz	1.8	L000640	RA 24
22.0	N/A	13	3.3	4.0	130×105	160	140	365	180×350×546	19.6	230 V; 50 Hz	2.2	L001249	RE 415 S
22.0	N/A	13	3.3	4.0	130×105	160	140	374	180×396×555	21.6	230 V; 50 Hz	2.2	L001333	RE 420 S
22.0	N/A	13	4.6	5.7	150×130	160	140	400	200×430×581	27.2	230 V; 50 Hz	2.3	L001335	RE 630 S
22.0	N/A	13	8.0	10.0	200×200	160	140	443	280×440×624	34.6	230 V; 50 Hz	2.5	L001336	RE 1050 S
22.0	N/A	13	9.3	12.0	200×200	200	180	443	250×435×624	30.0	230 V; 50 Hz	2.3	L001337	RE 1225 S
22.0	N/A	13	14.0	20.0	300×350	160	140	443	350×570×624	37.0	230 V; 50 Hz	2.3	L001338	RE 2025 S
22.0	M16×1	13	3.3	4.0	130×105	160	140	365	180×350×546	20.0	230 V; 50 Hz	2.8	L001256	RE 415 G
22.0	M16×1	13	3.3	4.0	130×105	160	140	374	180×396×555	22.0	230 V; 50 Hz	2.8	L001339	RE 420 G
22.0	M16×1	13	4.6	5.7	150×130	160	140	400	200×430×581	27.6	230 V; 50 Hz	2.9	L001341	RE 630 G
22.0	M16×1	13	8.0	10.0	200×200	160	140	443	280×440×624	35.0	230 V; 50 Hz	3.1	L001342	RE 1050 G
22.0	M16×1	13	9.3	12.0	200×200	200	180	443	250×435×624	30.4	230 V; 50 Hz	2.9	L001343	RE 1225 G
22.0	M16×1	13	14.0	20.0	300×350	160	140	443	350×570×624	37.4	230 V; 50 Hz	2.9	L001344	RE 2025 G

LAUDA Cooling thermostats

Technical data according to DIN 12876 standard

Device type	Working temperature range °C	Temperature stability ±K	Safety fittings	Heater power max. kW	Cooling output kW														Pump type	Pump pressure max. bar
					20 °C	10 °C	0 °C	-10 °C	-20 °C	-25 °C	-30 °C	-40 °C	-50 °C	-60 °C	-70 °C	-80 °C	-90 °C	-100 °C		

LAUDA PRO / Page 60

RP 2040	-40 ... 200	0.01	III, FL	3.6	0.80 ³	0.80 ³	0.80 ³	0.60 ³	0.40 ²	-	0.19 ²	0.06 ²	-	-	-	-	-	-	V	-
RP 2045	-45 ... 200	0.01	III, FL	3.6	1.50 ³	1.43 ³	1.17 ³	0.84 ³	0.52 ²	-	0.28 ²	0.13 ²	-	-	-	-	-	-	V	-
RP 3035	-35 ... 200	0.01	III, FL	3.6	0.80 ³	0.80 ³	0.80 ³	0.58 ³	0.35 ²	-	0.16 ²	-	-	-	-	-	-	-	V	-
RP 1090	-90 ... 200	0.01	III, FL	3.6	0.80 ³	0.75 ³	0.72 ³	0.69 ³	0.66 ²	-	0.63 ²	0.60 ²	0.54 ²	0.37 ²	0.24 ²	0.11 ²	0.02 ²	-	V	-
RP 2090	-90 ... 200	0.01	III, FL	3.6	0.80 ³	0.71 ³	0.68 ³	0.65 ³	0.62 ²	-	0.61 ²	0.58 ²	0.52 ²	0.34 ²	0.18 ²	0.07 ²	0.01 ²	-	V	-
RP 10100	-100 ... 200	0.01	III, FL	3.6	0.40 ³	0.40 ³	0.40 ³	0.40 ³	0.40 ²	-	0.39 ²	0.37 ²	0.35 ²	0.32 ²	0.25 ²	0.17 ²	0.06 ²	0.01 ²	V	-
RP 2040 C	-40 ... 200	0.01	III, FL	3.6	0.80 ³	0.80 ³	0.80 ³	0.60 ³	0.40 ²	-	0.19 ²	0.06 ²	-	-	-	-	-	-	V	-
RP 2045 C	-45 ... 200	0.01	III, FL	3.6	1.50 ³	1.43 ³	1.17 ³	0.84 ³	0.52 ²	-	0.28 ²	0.13 ²	-	-	-	-	-	-	V	-
RP 3035 C	-35 ... 200	0.01	III, FL	3.6	0.80 ³	0.80 ³	0.80 ³	0.58 ³	0.35 ²	-	0.16 ²	-	-	-	-	-	-	-	V	-
RP 1090 C	-90 ... 200	0.01	III, FL	3.6	0.80 ³	0.75 ³	0.72 ³	0.69 ³	0.66 ²	-	0.63 ²	0.60 ²	0.54 ²	0.37 ²	0.24 ²	0.11 ²	0.02 ²	-	V	-
RP 2090 C	-90 ... 200	0.01	III, FL	3.6	0.80 ³	0.71 ³	0.68 ³	0.65 ³	0.62 ²	-	0.61 ²	0.58 ²	0.52 ²	0.34 ²	0.18 ²	0.07 ²	0.01 ²	-	V	-
RP 10100 C	-100 ... 200	0.01	III, FL	3.6	0.40 ³	0.40 ³	0.40 ³	0.40 ³	0.40 ²	-	0.39 ²	0.37 ²	0.35 ²	0.32 ²	0.25 ²	0.17 ²	0.06 ²	0.01 ²	V	-

LAUDA Proline Kryomats / Page 62

RP 4050 C	-50 ... 200	0.05	III, FL	3.5	5.00 ¹	-	3.00 ¹	-	1.60 ¹	-	1.00 ¹	0.50 ¹	0.25 ¹	-	-	-	-	-	V	0.5
RP 4050 CW	-50 ... 200	0.05	III, FL	3.5	6.00 ¹	-	3.50 ¹	-	1.80 ¹	-	1.10 ¹	0.60 ¹	0.25 ¹	-	-	-	-	-	V	0.5
RP 3090 C	-90 ... 200	0.05	III, FL	3.5	3.00 ¹	-	2.90 ¹	-	2.50 ¹	-	2.30 ¹	2.00 ¹	1.60 ¹	1.30 ¹	0.80 ¹	0.50 ¹	0.15 ¹	-	V	0.5
RP 3090 CW	-90 ... 200	0.05	III, FL	3.5	4.00 ¹	-	3.70 ¹	-	3.10 ¹	-	2.70 ¹	2.00 ¹	1.60 ¹	1.30 ¹	0.80 ¹	0.50 ¹	0.15 ¹	-	V	0.5
RP 4090 C	-90 ... 200	0.05	III, FL	3.5	3.00 ¹	-	2.90 ¹	-	2.50 ¹	-	2.30 ¹	2.00 ¹	1.60 ¹	1.30 ¹	0.80 ¹	0.50 ¹	0.15 ¹	-	V	0.5
RP 4090 CW	-90 ... 200	0.05	III, FL	3.5	4.00 ¹	-	3.70 ¹	-	3.10 ¹	-	2.70 ¹	2.00 ¹	1.60 ¹	1.30 ¹	0.80 ¹	0.50 ¹	0.15 ¹	-	V	0.5

¹Pump output step 2 ²Pump output step 4 ³Pump output step 8 All device types with mark »W« are water-cooled

Pump flow max. pressure L/min	Pump connection thread mm	Nipples \varnothing_e	Bath volume min. L	Bath volume max. L	Bath opening (W x D) mm	Bath depth mm	Usable depth mm	Height top of bath mm	Dimensions (W x D x H) mm	Weight kg	Power supply V; Hz	Loading max. kW	Cat. No.	Device type
-	N/A	-	12.5	21.0	300x290	200	180	568	400x565x680	54.0	230 V; 50 Hz	3.7	L000007	RP 2040
-	N/A	-	12.5	21.0	300x290	200	180	568	400x565x680	59.0	230 V; 50 Hz	3.7	L000008	RP 2045
-	N/A	-	17.5	29.5	340x375	200	180	568	440x600x680	57.0	230 V; 50 Hz	3.7	L000009	RP 3035
-	N/A	-	6.5	10.5	240x150	200	180	618	440x600x730	83.0	230 V; 50 Hz	3.7	L000010	RP 1090
-	N/A	-	12.5	21.0	300x290	200	180	618	500x600x730	89.0	230 V; 50 Hz	3.7	L000011	RP 2090
-	N/A	-	6.5	10.5	240x150	200	180	618	500x600x730	83.0	230 V; 50 Hz	3.7	L000012	RP 10100
-	N/A	-	12.5	21.0	300x290	200	180	568	400x565x730	54.0	230 V; 50 Hz	3.7	L000013	RP 2040 C
-	N/A	-	12.5	21.0	300x290	200	180	568	400x565x730	59.0	230 V; 50 Hz	3.7	L000014	RP 2045 C
-	N/A	-	17.5	29.5	340x375	200	180	568	440x600x730	57.0	230 V; 50 Hz	3.7	L000015	RP 3035 C
-	N/A	-	6.5	10.5	240x150	200	180	618	440x600x780	83.0	230 V; 50 Hz	3.7	L000016	RP 1090 C
-	N/A	-	12.5	21.0	300x290	200	180	618	500x600x780	89.0	230 V; 50 Hz	3.7	L000017	RP 2090 C
-	N/A	-	6.5	10.5	240x150	200	180	618	500x600x780	83.0	230 V; 50 Hz	3.7	L000018	RP 10100 C
19.0	M16x1	13	32.0	44.0	350x350	250	230	905	600x700x1216	130.0	400 V; 3/N/PE; 50 Hz	5.0	L001653	RP 4050 C
19.0	M16x1	13	32.0	44.0	350x350	250	230	905	600x700x1216	130.0	400 V; 3/N/PE; 50 Hz	5.0	L001657	RP 4050 CW
19.0	M16x1	13	23.0	31.0	350x200	250	230	905	600x700x1216	155.0	400 V; 3/N/PE; 50 Hz	7.0	L001654	RP 3090 C
19.0	M16x1	13	23.0	31.0	350x200	250	230	905	600x700x1216	155.0	400 V; 3/N/PE; 50 Hz	7.0	L001658	RP 3090 CW
19.0	M16x1	13	32.0	44.0	350x350	250	230	905	600x700x1216	155.0	400 V; 3/N/PE; 50 Hz	7.0	L001655	RP 4090 C
19.0	M16x1	13	32.0	44.0	350x350	250	230	905	600x700x1216	155.0	400 V; 3/N/PE; 50 Hz	7.0	L001659	RP 4090 CW

LAUDA Cooling thermostats

Power supply variants

Device type	Power supply V; Hz	Heater power max. kW	Loading max. kW	Plug code*	Cat. No.	Device type	Power supply V; Hz	Heater power max. kW	Loading max. kW	Plug code*	Cat. No.
LAUDA Alpha / Page 56											
RA 8	100 V; 50/60 Hz	1.0	1.3	14	L000653	RA 24	100 V; 50/60 Hz	1.0	1.3	14	L000655
RA 8	115 V; 60 Hz	1.2	1.5	14	L000650	RA 24	115 V; 60 Hz	1.2	1.5	14	L000652
RA 8	220 V; 60 Hz	1.4	1.8	17	L000647	RA 24	220 V; 60 Hz	1.4	1.8	17	L000649
RA 12	100 V; 50/60 Hz	1.0	1.3	14	L000654						
RA 12	115 V; 60 Hz	1.2	1.5	14	L000651						
RA 12	220 V; 60 Hz	1.4	1.8	17	L000648						
LAUDA ECO / Page 58											
RE 415 S	115 V; 60 Hz	1.3	1.4	14	L001433	RE 1050 S	100 V; 50/60 Hz	1.0	1.5	14	L001465
RE 415 S	220 V; 60 Hz	1.8	2.1	3	L001405	RE 1050 S	115 V; 60 Hz	1.3	1.4	14	L001437
RE 415 S	220 V; 60 Hz	1.8	2.1	2	L002073	RE 1050 S	220 V; 60 Hz	1.8	2.4	3	L001409
RE 415 G	115 V; 60 Hz	1.3	1.4	14	L001440	RE 1050 S	220 V; 60 Hz	1.8	2.4	2	L002077
RE 415 G	220 V; 60 Hz	2.4	2.6	3	L001412	RE 1050 G	100 V; 50/60 Hz	1.0	1.5	14	L001472
RE 415 G	220 V; 60 Hz	2.4	2.6	2	L002080	RE 1050 G	115 V; 60 Hz	1.3	1.4	14	L001444
RE 420 S	100 V; 50/60 Hz	1.0	1.2	14	L001462	RE 1050 G	220 V; 60 Hz	2.4	2.9	3	L001416
RE 420 S	115 V; 60 Hz	1.3	1.4	14	L001434	RE 1225 S	100 V; 50/60 Hz	1.0	1.3	14	L001466
RE 420 S	220 V; 60 Hz	1.8	2.1	3	L001406	RE 1225 S	115 V; 60 Hz	1.3	1.4	14	L001438
RE 420 S	220 V; 60 Hz	1.8	2.1	2	L002074	RE 1225 S	220 V; 60 Hz	1.8	2.1	2	L002078
RE 420 G	100 V; 50/60 Hz	1.0	1.2	14	L001469	RE 1225 S	220 V; 60 Hz	1.8	2.1	3	L001410
RE 420 G	115 V; 60 Hz	1.3	1.4	14	L001441	RE 1225 G	100 V; 50/60 Hz	1.0	1.3	14	L001473
RE 420 G	220 V; 60 Hz	2.4	2.6	3	L001413	RE 1225 G	115 V; 60 Hz	1.3	1.4	14	L001445
RE 630 S	100 V; 50/60 Hz	1.0	1.3	14	L001464	RE 1225 G	220 V; 60 Hz	2.4	2.7	3	L001417
RE 630 S	115 V; 60 Hz	1.3	1.4	14	L001436	RE 2025 S	100 V; 50/60 Hz	1.0	1.3	14	L001467
RE 630 S	220 V; 60 Hz	1.8	2.1	3	L001408	RE 2025 S	115 V; 60 Hz	1.3	1.4	14	L001439
RE 630 S	220 V; 60 Hz	1.8	2.1	2	L002076	RE 2025 S	220 V; 60 Hz	1.8	2.1	2	L002079
RE 630 G	100 V; 50/60 Hz	1.0	1.3	14	L001471	RE 2025 S	220 V; 60 Hz	1.8	2.1	3	L001411
RE 630 G	115 V; 60 Hz	1.3	1.4	14	L001443	RE 2025 G	100 V; 50/60 Hz	1.0	1.3	14	L001474
RE 630 G	220 V; 60 Hz	2.4	2.7	2	L002083	RE 2025 G	115 V; 60 Hz	1.3	1.4	14	L001446
RE 630 G	220 V; 60 Hz	2.4	2.7	3	L001415	RE 2025 G	220 V; 60 Hz	2.4	2.7	3	L001418

*All data for the plug codes can be found on page 150

LAUDA Cooling thermostats

Power supply variants

Device type	Power supply V; Hz	Heater power max. kW	Loading max. kW	Plug code*	Cat. No.	Device type	Power supply V; Hz	Heater power max. kW	Loading max. kW	Plug code*	Cat. No.
LAUDA PRO / Page 60											
RP 2040	100 V; 50/60 Hz	1.3	1.6	32	L000538	RP 2045 C	200 V; 50/60 Hz	2.7	3.2	2	L000475
RP 2040	100 V; 50/60 Hz	1.3	1.5	14	L000530	RP 2045 C	200 V; 50/60 Hz	2.7	3.2	3	L000491
RP 2040	120 V; 60 Hz	1.9	1.9	32	L000458	RP 2045 C	200 V; 50/60 Hz	2.7	3.2	32	L000523
RP 2040	120 V; 60 Hz	1.9	1.9	4	L000450	RP 2045 C	200 V; 50/60 Hz	2.7	3.2	31	L000507
RP 2040	200 V; 50/60 Hz	2.7	3.2	31	L000498	RP 2045 C	208-220 V; 60 Hz	3.3	3.5	2	L000573
RP 2040	200 V; 50/60 Hz	2.7	3.2	32	L000514	RP 2045 C	208-220 V; 60 Hz	3.3	3.5	31	L000427
RP 2040	200 V; 50/60 Hz	2.7	3.2	3	L000482	RP 2045 C	208-220 V; 60 Hz	3.3	3.5	3	L000315
RP 2040	200 V; 50/60 Hz	2.7	3.2	2	L000466	RP 2045 C	208-220 V; 60 Hz	3.3	3.5	32	L000443
RP 2040	208-220 V; 60 Hz	3.3	3.5	32	L000434	RP 3035	100 V; 50/60 Hz	1.3	1.6	32	L000539
RP 2040	208-220 V; 60 Hz	3.3	3.5	2	L000564	RP 3035	100 V; 50/60 Hz	1.3	1.5	14	L000531
RP 2040	208-220 V; 60 Hz	3.3	3.5	31	L000418	RP 3035	120 V; 60 Hz	1.9	1.9	32	L000459
RP 2040	208-220 V; 60 Hz	3.3	3.5	3	L000306	RP 3035	120 V; 60 Hz	1.9	1.9	4	L000451
RP 2040 C	100 V; 50/60 Hz	1.3	1.5	14	L000534	RP 3035	200 V; 50/60 Hz	2.7	3.2	31	L000500
RP 2040 C	100 V; 50/60 Hz	1.3	1.6	32	L000542	RP 3035	200 V; 50/60 Hz	2.7	3.2	32	L000516
RP 2040 C	120 V; 60 Hz	1.9	1.9	32	L000462	RP 3035	200 V; 50/60 Hz	2.7	3.2	2	L000468
RP 2040 C	120 V; 60 Hz	1.9	1.9	4	L000454	RP 3035	200 V; 50/60 Hz	2.7	3.2	3	L000484
RP 2040 C	200 V; 50/60 Hz	2.7	3.2	3	L000490	RP 3035	208-220 V; 60 Hz	3.3	3.5	31	L000420
RP 2040 C	200 V; 50/60 Hz	2.7	3.2	31	L000506	RP 3035	208-220 V; 60 Hz	3.3	3.5	3	L000308
RP 2040 C	200 V; 50/60 Hz	2.7	3.2	32	L000522	RP 3035	208-220 V; 60 Hz	3.3	3.5	2	L000566
RP 2040 C	200 V; 50/60 Hz	2.7	3.2	2	L000474	RP 3035	208-220 V; 60 Hz	3.3	3.5	32	L000436
RP 2040 C	208-220 V; 60 Hz	3.3	3.5	3	L000314	RP 3035 C	100 V; 50/60 Hz	1.3	1.5	14	L000535
RP 2040 C	208-220 V; 60 Hz	3.3	3.5	32	L000442	RP 3035 C	100 V; 50/60 Hz	1.3	1.6	32	L000543
RP 2040 C	208-220 V; 60 Hz	3.3	3.5	31	L000426	RP 3035 C	120 V; 60 Hz	1.9	1.9	4	L000455
RP 2040 C	208-220 V; 60 Hz	3.3	3.5	2	L000572	RP 3035 C	120 V; 60 Hz	1.9	1.9	32	L000463
RP 2045	200 V; 50/60 Hz	2.7	3.2	31	L000499	RP 3035 C	200 V; 50/60 Hz	2.7	3.2	2	L000476
RP 2045	200 V; 50/60 Hz	2.7	3.2	3	L000483	RP 3035 C	200 V; 50/60 Hz	2.7	3.2	32	L000524
RP 2045	200 V; 50/60 Hz	2.7	3.2	2	L000467	RP 3035 C	200 V; 50/60 Hz	2.7	3.2	31	L000508
RP 2045	200 V; 50/60 Hz	2.7	3.2	32	L000515	RP 3035 C	200 V; 50/60 Hz	2.7	3.2	3	L000492
RP 2045	208-220 V; 60 Hz	3.3	3.5	2	L000565	RP 3035 C	208-220 V; 60 Hz	3.3	3.5	31	L000428
RP 2045	208-220 V; 60 Hz	3.3	3.5	31	L000419	RP 3035 C	208-220 V; 60 Hz	3.3	3.5	3	L000316
RP 2045	208-220 V; 60 Hz	3.3	3.5	32	L000435	RP 3035 C	208-220 V; 60 Hz	3.3	3.5	2	L000574
RP 2045	208-220 V; 60 Hz	3.3	3.5	3	L000307	RP 3035 C	208-220 V; 60 Hz	3.3	3.5	32	L000444

Device type	Power supply V; Hz	Heater power max. kW	Loading max. kW	Plug code*	Cat. No.	Device type	Power supply V; Hz	Heater power max. kW	Loading max. kW	Plug code*	Cat. No.
LAUDA PRO / Page 60											
RP 1090	200 V; 50/60 Hz	2.7	3.2	3	L000485	RP 2090 C	200 V; 50/60 Hz	2.7	3.2	2	L000478
RP 1090	200 V; 50/60 Hz	2.7	3.2	32	L000517	RP 2090 C	200 V; 50/60 Hz	2.7	3.2	3	L000494
RP 1090	200 V; 50/60 Hz	2.7	3.2	2	L000469	RP 2090 C	200 V; 50/60 Hz	2.7	3.2	32	L000526
RP 1090	200 V; 50/60 Hz	2.7	3.2	31	L000501	RP 2090 C	200 V; 50/60 Hz	2.7	3.2	31	L000510
RP 1090	208-220 V; 60 Hz	3.3	3.5	32	L000437	RP 2090 C	208-220 V; 60 Hz	3.3	3.5	3	L000318
RP 1090	208-220 V; 60 Hz	3.3	3.5	3	L000309	RP 2090 C	208-220 V; 60 Hz	3.3	3.5	32	L000446
RP 1090	208-220 V; 60 Hz	3.3	3.5	2	L000567	RP 2090 C	208-220 V; 60 Hz	3.3	3.5	31	L000430
RP 1090	208-220 V; 60 Hz	3.3	3.5	31	L000421	RP 2090 C	208-220 V; 60 Hz	3.3	3.5	2	L000576
RP 1090 C	200 V; 50/60 Hz	2.7	3.2	32	L000525	RP 10100	200 V; 50/60 Hz	2.7	3.2	32	L000519
RP 1090 C	200 V; 50/60 Hz	2.7	3.2	2	L000477	RP 10100	200 V; 50/60 Hz	2.7	3.2	31	L000503
RP 1090 C	200 V; 50/60 Hz	2.7	3.2	31	L000509	RP 10100	200 V; 50/60 Hz	2.7	3.2	2	L000471
RP 1090 C	200 V; 50/60 Hz	2.7	3.2	3	L000493	RP 10100	200 V; 50/60 Hz	2.7	3.2	3	L000487
RP 1090 C	208-220 V; 60 Hz	3.3	3.5	31	L000429	RP 10100	208-220 V; 60 Hz	3.3	3.5	32	L000439
RP 1090 C	208-220 V; 60 Hz	3.3	3.5	2	L000575	RP 10100	208-220 V; 60 Hz	3.3	3.5	31	L000423
RP 1090 C	208-220 V; 60 Hz	3.3	3.5	32	L000445	RP 10100	208-220 V; 60 Hz	3.3	3.5	2	L000569
RP 1090 C	208-220 V; 60 Hz	3.3	3.5	3	L000317	RP 10100	208-220 V; 60 Hz	3.3	3.5	3	L000311
RP 2090	200 V; 50/60 Hz	2.7	3.2	2	L000470	RP 10100 C	200 V; 50/60 Hz	2.7	3.2	32	L000527
RP 2090	200 V; 50/60 Hz	2.7	3.2	32	L000518	RP 10100 C	200 V; 50/60 Hz	2.7	3.2	31	L000511
RP 2090	200 V; 50/60 Hz	2.7	3.2	31	L000502	RP 10100 C	200 V; 50/60 Hz	2.7	3.2	3	L000495
RP 2090	200 V; 50/60 Hz	2.7	3.2	3	L000486	RP 10100 C	200 V; 50/60 Hz	2.7	3.2	2	L000479
RP 2090	208-220 V; 60 Hz	3.3	3.5	32	L000438	RP 10100 C	208-220 V; 60 Hz	3.3	3.5	3	L000319
RP 2090	208-220 V; 60 Hz	3.3	3.5	2	L000568	RP 10100 C	208-220 V; 60 Hz	3.3	3.5	31	L000431
RP 2090	208-220 V; 60 Hz	3.3	3.5	3	L000310	RP 10100 C	208-220 V; 60 Hz	3.3	3.5	32	L000447
RP 2090	208-220 V; 60 Hz	3.3	3.5	31	L000422	RP 10100 C	208-220 V; 60 Hz	3.3	3.5	2	L000577
LAUDA Proline Kryomats / Page 62											
RP 4050 C	200 V; 3/PE; 50/60 Hz	2.8	5.0	31	L001701	RP 3090 CW	200 V; 3/PE; 50/60 Hz	2.8	7.0	31	L001706
RP 4050 C	208 V; 3/PE; 60 Hz	3.0	5.0	31	L001677	RP 3090 CW	208 V; 3/PE; 60 Hz	3.0	7.0	31	L001682
RP 4050 CW	200 V; 3/PE; 50/60 Hz	2.8	5.0	31	L001705	RP 4090 C	200 V; 3/PE; 50/60 Hz	2.8	7.0	31	L001703
RP 4050 CW	208 V; 3/PE; 60 Hz	3.0	5.0	31	L001681	RP 4090 C	208 V; 3/PE; 60 Hz	3.0	7.0	31	L001679
RP 3090 C	200 V; 3/PE; 50/60 Hz	2.8	7.0	31	L001702	RP 4090 CW	200 V; 3/PE; 50/60 Hz	2.8	7.0	31	L001707
RP 3090 C	208 V; 3/PE; 60 Hz	3.0	7.0	31	L001678	RP 4090 CW	208 V; 3/PE; 60 Hz	3.0	7.0	31	L001683

*All data for the plug codes can be found on page 150 All device types with mark >W< are water-cooled

LAUDA Cooling thermostats

More characteristics

LAUDA Alpha / Page 56

PUMP CHARACTERISTIC Water

Pressure bar

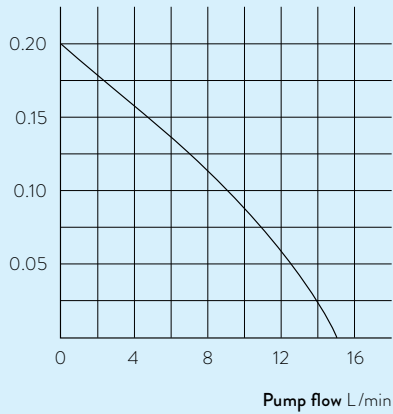

LAUDA ECO / Page 58

COOLING PERFORMANCE According to DIN 12876

Bath temperature °C

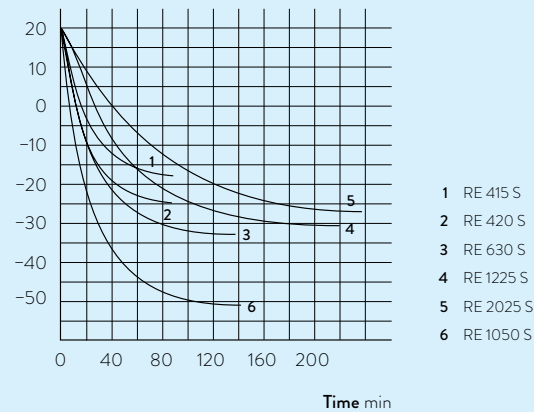

LAUDA Proline Kryomats / Page 62

COOLING PERFORMANCE According to DIN 12876

Bath temperature °C

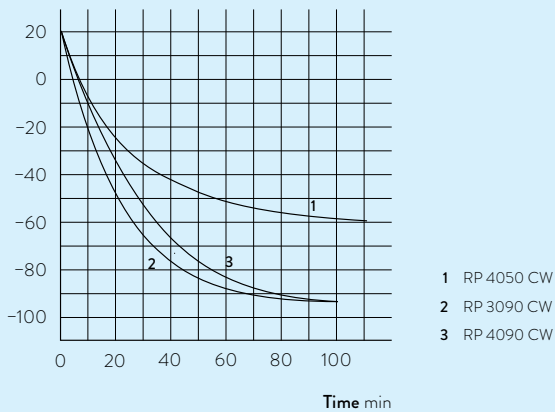

LAUDA CIRCULATION AND PROCESS THERMOSTATS

°LAUDA

Specific application examples

- Refractometer
- Polarimeter
- Single-use bioreactors
- Extruder for food production
- Micro reactors
- Responsive control in chemical/pharmaceutical surroundings
- Climate chambers
- Space simulation
- Electric mobility; battery testing
- Test rigs
- Stress test
- Crystallization regulation
- Freeze-drying
- Micro structures
- Coating plants



LAUDA LOOP

The compact, lightweight circulation thermostat for external applications from 4 to 80 °C

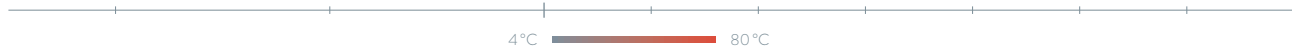

Extremely versatile, flexibly usable thermo-electric circulation thermostat

The LAUDA LOOP circulation thermostat is sure to impress with its constant temperature range between 4 and 80 °C. Its compact construction and low weight, as well as wide voltage input range of 100 to 240 volts, make it possible to put it to use flexibly and spontaneously anywhere in the world – the ›Plug and Play‹ setup with quick-fit couplings makes it especially easy to use. The intuitive three-button softkey operation and simple menu navigation in five available languages via the well-lit, high-contrast OLED display make using the device a breeze.



Simple three-button controls with OLED display



Standard-issue RS 232 interface for system integration into processes

PUMP CHARACTERISTIC Water

Pressure bar

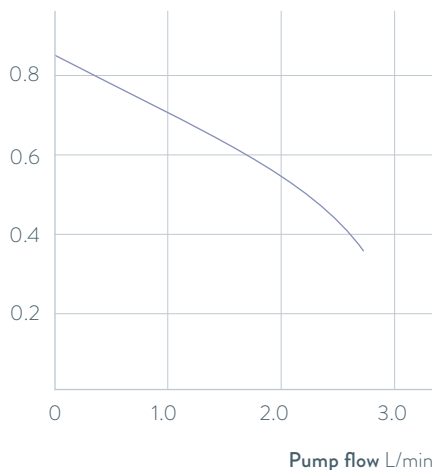

Important functions

- Pump connections with quick-fit couplings for easy consumer changes
- Can be operated with non-flammable liquids (water, water/glycol)
- Cooling technology free of coolant ensures silent, low-vibration operation

Included accessories

Hose nozzles for pump connections

Further accessories

Tubing

All technical data and power supply variants can be found in the ›Technical data‹ section.

More at www.lauda.de/1748



LAUDA LOOP

The L100 and L250 air-cooled device types achieve a cooling capacity of 120 and 250 watt. The devices are primarily for use at constant temperatures with low power requirements. Both device types are especially energy-efficient and silent in partial-load operation.



LAUDA PRO

Compact circulation thermostats for professional temperature control from -90 to 250 °C



Flexible operation, outstanding performance characteristics

LAUDA PRO is the cutting-edge product line with an outstanding overall concept: The circulation thermostats with small, active volumes of liquid enable rapid temperature changes in external applications. The innovative Base or Command Touch operating units can be detached and used as a remote control. The cooling thermostats come equipped with hybrid cooling as standard, which allows for additional cooling of the refrigerating machine with water.



Many basic functions with the economic Base variant

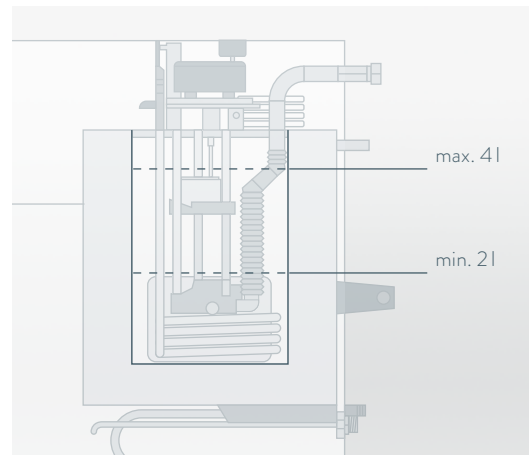

The small filling volume and powerful vario flex pump offer fast temperature changes with low operating costs and material consumption

PUMP CHARACTERISTICS Water

Pressure bar

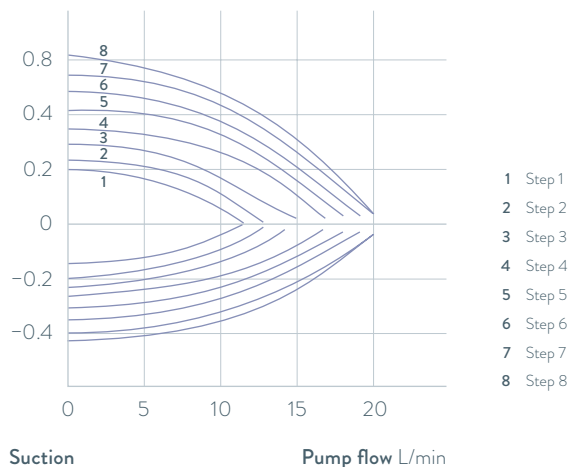

Suction

Pump flow L/min

Important functions

- Tower design for small footprint
- LAUDA Vario Flex Pump with 8 available output levels, pump connections at rear
- SmartCool system for digital, energy-saving cooling control including automatic compressor control

Included accessories

Tubing nipples for pumps and cooling water connection

Further accessories

Tubing, interface modules

All technical data and power supply variants can be found in the ›Technical data‹ section.

More at www.lauda.de/1750



LAUDA PRO

The PRO heating circulation thermostats are designed for external applications up to 250 °C. The compact construction permits space-saving installation of the thermostats. An integrated cooling coil, fitted as standard, provides cooling. The PRO cooling circulation thermostats are ideal for external applications where rapid temperature changes are required. The cooling output of 0.6 and 0.8 kW or 1.5 kW, combined with a very low filling volume permit these rapid temperature changes.





LAUDA Integral T

The bypass in the Integral T reduces the linear pump characteristics when it opens. Pressure-sensitive applications can therefore be protected by reducing the discharge pressure. The digital pressure indication in the Integral T display facilitates manual adjustment of the discharge pressure by means of a bypass. The robust and powerful immersion pressure pump ensures reliable, leak-free and safe operation. The independent internal circulation of the heat transfer liquid ensures maximum heating and cooling capacity.



LAUDA Integral XT

High-performance process thermostats from 1.5 to 20 kW for temperature control from -90 to 320 °C

-90°C

320°C

Process thermostats for dynamic temperature control tasks

LAUDA Integral XT process thermostats operate according to the flow principle with a cold oil blanket which allows the utilization of temperature control liquid over a significantly larger temperature range. The Integral XT process thermostats are ideal for dynamic temperature control tasks. The electronically controlled, magnetically coupled pump can set the flow rate optimally both for the requirements of pressure-sensitive consumers and for applications with high hydraulic resistance. An internal bypass also increases flexibility. Integral thermostats can be flexibly integrated in various communication scenarios thanks to the integrated web server, monitoring and control via PC or mobile devices and the modular interface concept.



TFT display with different screens or temperature profiles



Bypass included as standard. For increased internal flow rates in applications requiring pressure limitations

INTEGRAL XT HYDRAULIC DIAGRAM

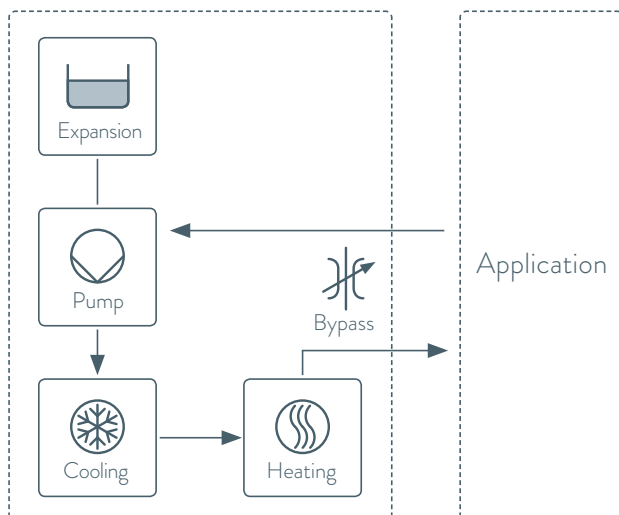

Important functions

- High-performance LAUDA Vario Pump (pressure pump) with 8 selectable output levels or flow pressure control
- Programmer with 150 temperature/time segments, can be divided into five programs
- Two additional module slots available for retrofit
- Operation in internal LAN possible on web server via PC or tablet/smartphone

Standard equipment

Ethernet and USB interfaces, Pt-100 and malfunction contact

Additional accessories

Hoses, adapters
Through-flow control systems

All technical data and power supply variants can be found in the »Technical data« section.

More at www.lauda.de/1754



LAUDA Integral XT

The Integral XT uses an eight-stage, robust and sealed magnetically coupled Vario pump with selectable characteristics to ensure a reliable supply to the consumer, even with high flow resistance. The menu-driven selection of the pump level enables optimum thermal connection of the application with the required discharge pressure and volume flow rate.



LAUDA Variocool

Cooling circulation thermostats from -20 to 80 °C
with cooling capacities up to 10 kW and powerful pumps

-20°C  80°C

Comprehensive spectrum of services for demanding temperature control tasks

The LAUDA Variocool with optional heater is a fully fledged circulation thermostat suitable for use with non-flammable heat transfer liquid within a moderate temperature range.

Equipment incorporating different pumps, individual interface module expansions and the option of external temperature control allow operation as a standalone unit or full integration in a process control system.



Malfunction Alarm contact included as standard, as well as module slots for additional interfaces



Flexible customization to applications due to optional heating and high performance pumps

PUMP CHARACTERISTIC Water

Pressure bar

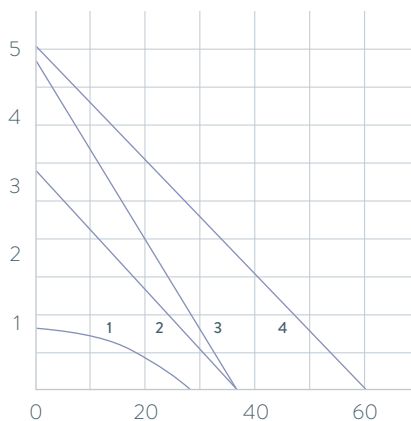

- 1 0,9 bar, 28 L/min
- 2 3,2 bar, 37 L/min
- 3 4,8 bar, 37 L/min
- 4 5,0 bar, 60 L/min

Pump flow L/min

Important functions

- Adjustable bypass for pressure limitation
- Filling opening at the top, drain tap at the rear
- Integrated programmer with 150 segments, can be divided into 5 programs
- Electronic level indicator and low-level alarm
- SmartCool system for digital, energy-saving cooling control, including automatic compressor control

Included accessories

Nipples, screw caps

Further accessories

Hoses, interface modules

All technical data and power supply variants can be found in the ›Technical data‹ section.

More at www.lauda.de/1756



LAUDA Variocool

All models are available in air and water-cooled versions (W) and fitted with moveable as well as fixable castors. High-performance circulation chillers in a tower design starting from the VC 5000 model are available with sound insulation.

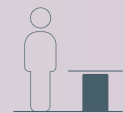

LAUDA Kryoheater Selecta

Process thermostats from -90 to 200 °C

for high-performance, professional temperature control



High-performance temperature control – impressive energy efficiency and reliability

LAUDA process thermostats from the Kryoheater Selecta (KHS) product line are synonymous with high-performance temperature control, long service life, ease of maintenance and intuitive operation. Depending on the lowest required temperature, either a two-level compressor (down to -60 °C) or a cascade cooling system (down to -90 °C) is used. Condenser cooling is performed using cooling water and is controlled continuously and precisely. An incremental switch offers energy-saving and low-wear partial load operation via automatic compressor control.



Secure and reliable use in production environment thanks to protection class IP 54 and the durable steel frame construction of the device

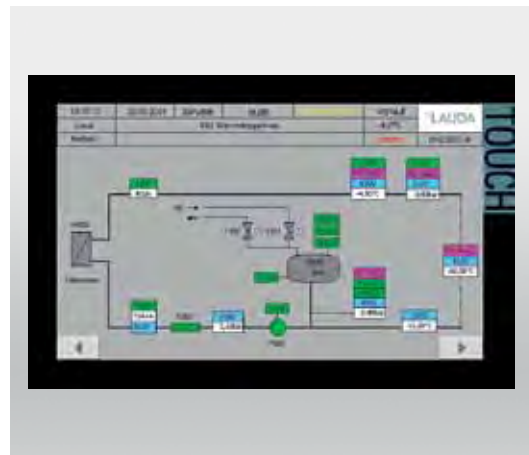

SPC controlling with 7" touch panel for intuitive operation and extensive data exchange with process control systems

COOLING POWER Heat transfer liquid: Kryo 65 / Kryo 90

Effective cooling power kW

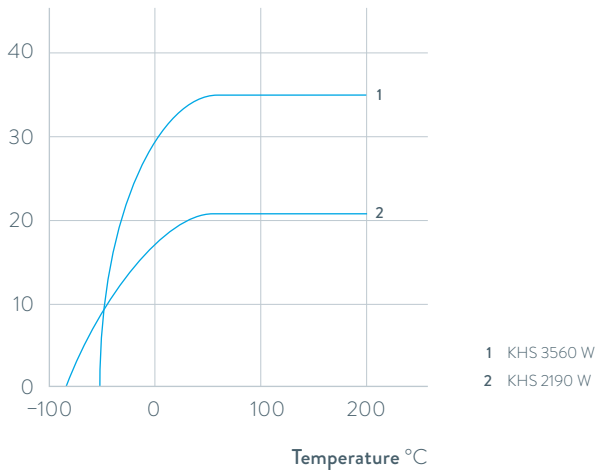

Important functions

- Powerful, magnetically-coupled pump (high flow rate, even with pressure losses), speed-controlled or with flow pressure control
- Prepared for pressurized nitrogen overlay
- Visualization of pending faults, status display of all system components
- User management
- Free choice of analog or digital interface included in the standard delivery, other optional interfaces also available
- USB port and LEMO connector for external temperature probe as standard

Available accessories

Thermostating and cooling water tubing, adapters

All technical data and power supply variants can be found in the ›Technical data‹ section.

More at www.lauda.de/1758



LAUDA Kryoheater Selecta

The Kryoheater Selecta product line consists of the two devices KHS 3560 W and KHS 2190 W, which can be used in chemical and pharmaceutical production. They also perform impressively in simulations of the environmental conditions at inspection stations in the automotive and aerospace industry. The process thermostats are designed for pressurized operation with nitrogen. Benefits include the increase in maximum operating temperature and the extension in service life of the heat transfer liquids.



LAUDA-Noah Semistat

Thermo-electric process thermostats
for the semiconductor industry from -20 to 90°C



Fast and precise temperature control for demanding processes

The thermoelectric Semistat temperature control system offers reproducible temperature control for plasma etching applications. This system dynamically controls the temperature of the electrostatic wafer chuck (ESC) and can be used in all types of etching processes. The LAUDA-Noah Semistat thermoelectric temperature control systems are based on established principles of heat transfer used for Peltier elements. These elements allow quick and precise temperature control required for complex processes involved in the manufacture of components progressively getting smaller and smaller in size.



Dynamic, stable temperature control

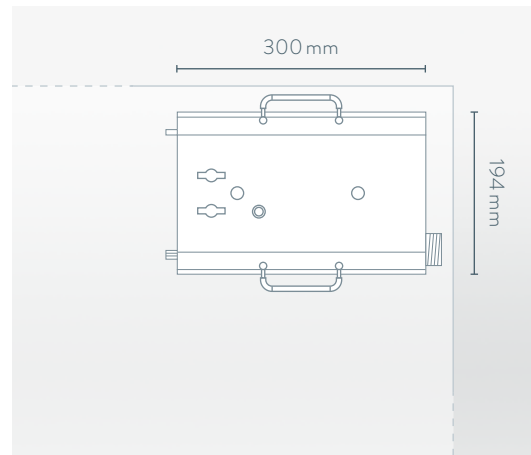

Small footprint

COOLING POWER dependent on process temperature and flow rate of cooling water

Effective cooling power kW

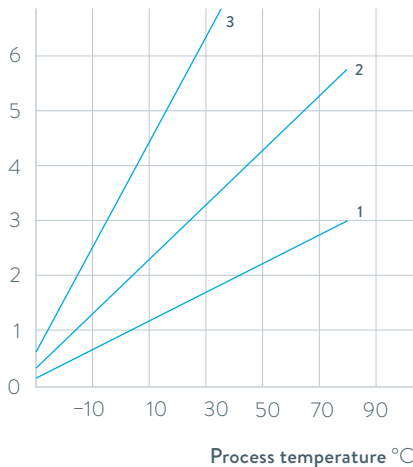

3 S4400
2 S2400
1 S1200

Important functions

- Compressor and refrigerant-free system with low energy consumption
- Smallest footprint in the industry, no footprint required for underfloor installation
- Extremely low volume of heat transfer fluid

Available accessories

Communications modules with remote control function (RS-485 protocol)

All technical data and power supply variants can be found in the ›Technical data‹ section.

More at www.lauda.de/1760



LAUDA-Noah Semistat

Semistat temperature control systems can reduce energy consumption by up to 90% compared to compressor-based systems.

Minimal space requirements with the option of underfloor installation at the point of use minimizes cleanroom use.



LAUDA Circulation and process thermostats

Device type overview

LAUDA LOOP / Page 80

LAUDA PRO / Page 82

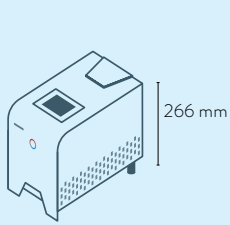

LOOP100

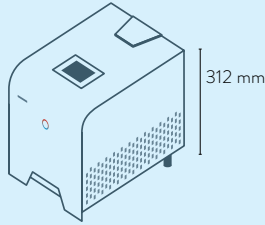

LOOP250

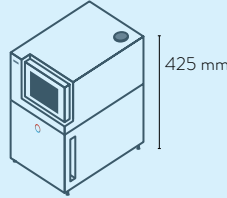

P2 E

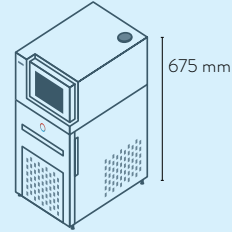

RP 240 EC
RP 245 EC
RP 250 EC

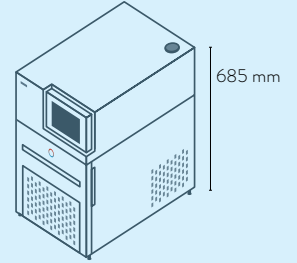

RP 290 EC

LAUDA Integral T / Page 84

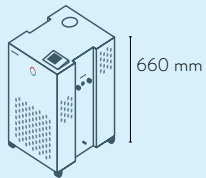

IN 130 T
IN 230 T
IN 230 TW

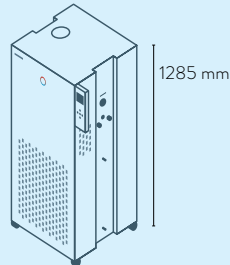

IN 530 T
IN 530 TW

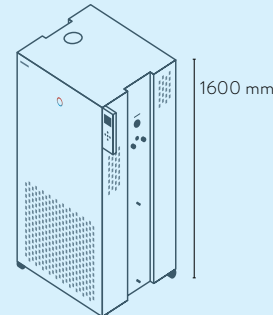

IN 1030 T

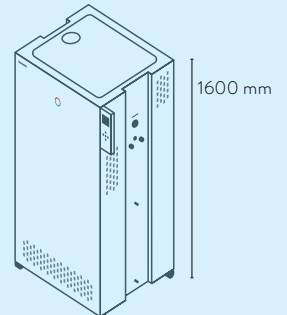

IN 1330 TW

LAUDA Integral XT / Page 86

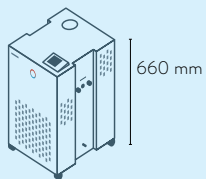

IN 150 XT
IN 250 XTW

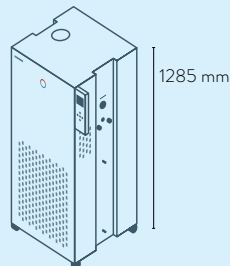

IN 550 XT / IN 550 XTW
IN 280 XT / IN 280 XTW
IN 750 XT
IN 950 XTW

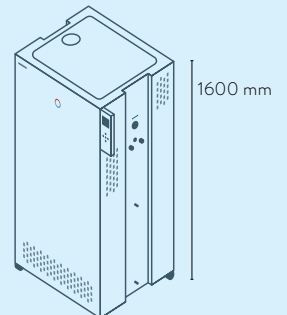

IN 1850 XTW
IN 590 XTW
IN 1590 XTW

LAUDA Variocool / Page 88

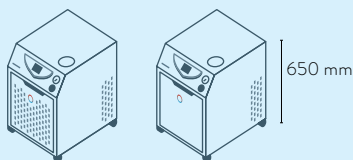

VC 1200
VC 2000
VC 1200 W
VC 2000 W

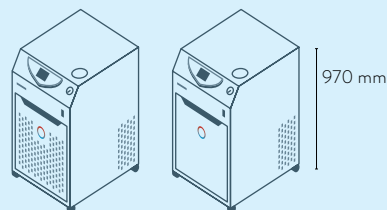

VC 3000
VC 5000
VC 3000 W
VC 5000 W

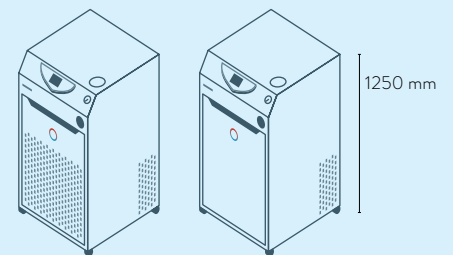

VC 7000
VC 10000
VC 7000 W
VC 10000 W

LAUDA Circulation and process thermostats

Interfaces

	Pt 100 (1)	Pt 100 (2)	USB	Ethernet	RS 232 / 485	Analog	Namur contact	Sub-D contact	Profibus	EtherCat M8	EtherCat RJ 45	Modbus	Profinet	Malfunction contact	Number of module slots, large	Number of module slots, small
LAUDA LOOP / Page 80	-	-	-	-	S	-	-	-	-	-	-	-	-	-	-	-
LAUDA PRO / Page 82	S	-	S	S	Z	Z	Z	Z	Z	Z	Z	-	-	-	1	-
LAUDA Integral T / Page 84	S	Z	S	S	Z	Z	Z	Z	Z	Z	Z	-	-	S	2	-
LAUDA Integral XT / Page 86	S	Z	S	S	Z	Z	Z	Z	Z	Z	Z	-	-	S	2	-
LAUDA Variocool / Page 88	Z	-	S	Z	Z	Z	Z	Z	Z	Z	Z	-	-	S	1	1
LAUDA Kryoheater Selecta / Page 90	S	-	S	-	OD	OD	-	-	OD	-	OD	-	OD	-	-	-

S = Series standard
 Z = Available as an accessory
 OD = optional (cannot be retrofitted)



LRZ 912
Analog module



LRZ 913
RS 232/485 interface



LRZ 914
Contact module with single input and single output (NAMUR)



LRZ 915
Contact module with 3 inputs and 3 outputs



LRZ 917
Profibus module



LRZ 918
Pt100/LiBus-Modul, small cover



LRZ 921
Ethernet module



LRZ 922
EtherCAT module with M8 connection

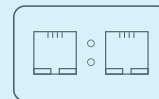

LRZ 923
EtherCAT module with RJ45 connection



LRZ 925
External Pt100/LiBus-module, large cover

LAUDA Kryoheater Selecta / Page 90

LAUDA-Noah Semistat / Page 92

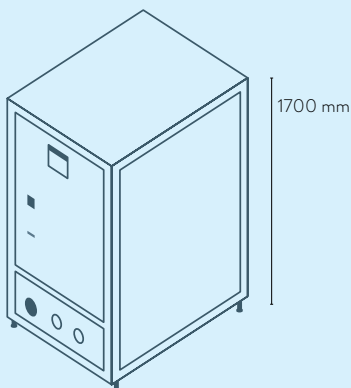

KHS 3560 W
KHS 2190 W

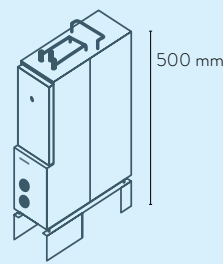

S 1200

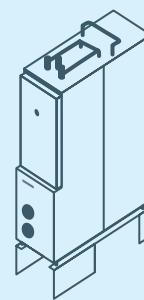

S 2400

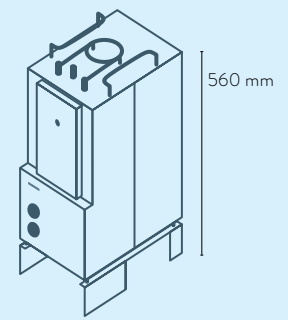

S 4400

LAUDA Circulation and process thermostats

Function overview

Operating element	LOOP	PROE	PROEC	Integral T	Integral XT	Variocool	Kryoheater Selecta
Display	OLED	OLED	TFT	TFT	TFT	TFT	TFT
Mode of operation	3-button softkey	Cursor softkey	Multi-touch	Cursor softkey	Cursor softkey	Cursor softkey	Multi-touch
Removable control	-	√	√	Z	Z	-	-
User management	-	-	√	Operator / Viewer	Operator / Viewer	-	√
Data logging, export to USB stick	-	-	√	√	√	-	√
1-point calibration	√	√	√	√	√	√	-
2-point calibration	√	√	√	√	√	-	-
Self-adaptation controller	-	-	√	√	√	-	-
Safety mode	-	√	√	√	√	-	-
Programmer, programs/segments	-	1 / 20	100 / 5000	5 / 150	5 / 150	5 / 150	OD
Programmer, tolerance range function	-	√	√	√	√	√	OD
Ramp function	-	-	√	Z	Z	-	OD
Timer function	-	-	√	√	√	-	-
Countdown function	-	-	√	-	-	-	-
Graphic temperature profile display	-	-	√	√	√	√	√
Pump pressure display (digital)	-	-	-	√	√	-	√
Adjustable bypass	-	-	-	√	√	√	-
Level indicator (digital)	-	√	√	√	√	√	√
Standby timer	√	√	√	√	√	√	√
Flow control instrument	-	-	-	-	-	Z	-
Flow pressure control	-	-	-	-	√	-	√
Flow measurement + control	-	-	-	-	Z	-	OD
Overflow	-	√	√	√	√	-	√
Low-level alarm	√	√	√	√	√	√	√
Drain tap	-	√	√	√	√	√	√

Z = Available as an accessory

OD = optional (cannot be retrofitted)

LAUDA Circulation and process thermostats

Technical data according to DIN 12876 standard

Device type	Working temperature range °C	Temperature stability ±K	Cooling of the refrigerating machine	Heater power max. kW	Cooling output kW													
					200 °C	100 °C	20 °C	10 °C	0 °C	-10 °C	-20 °C	-30 °C	-40 °C	-50 °C	-60 °C	-70 °C	-80 °C	-90 °C
LAUDA LOOP / Page 80																		
LOOP 100	4 ... 80	0.10	Air	0.2	-	-	0.12	0.06	-	-	-	-	-	-	-	-	-	-
LOOP 250	4 ... 80	0.10	Air	0.4	-	-	0.25	0.13	-	-	-	-	-	-	-	-	-	-
LAUDA PRO / Page 82																		
P 2 E	80 ... 250	0.05	Water	2.5	-	-	-	-	-	-	-	-	-	-	-	-	-	-
P 2 EC	80 ... 250	0.05	Water	2.5	-	-	-	-	-	-	-	-	-	-	-	-	-	-
RP 240 E	-40 ... 200	0.05	Hybrid	2.5	-	-	0.60 ³	0.60 ³	0.60 ³	0.41 ³	0.24 ²	0.12 ²	0.02 ¹	-	-	-	-	-
RP 240 EC	-40 ... 200	0.05	Hybrid	2.5	-	-	0.60 ³	0.60 ³	0.60 ³	0.41 ³	0.24 ²	0.12 ²	0.02 ¹	-	-	-	-	-
RP 245 E	-45 ... 200	0.05	Hybrid	2.5	-	-	0.80 ³	0.80 ³	0.80 ³	0.53 ³	0.34 ²	0.15 ²	0.04 ²	-	-	-	-	-
RP 245 EC	-45 ... 200	0.05	Hybrid	2.5	-	-	0.80 ³	0.80 ³	0.80 ³	0.53 ³	0.34 ²	0.15 ²	0.04 ²	-	-	-	-	-
RP 250 E	-50 ... 200	0.05	Hybrid	2.5	-	-	1.50 ³	1.44 ³	1.20 ³	0.84 ³	0.54 ²	0.29 ²	0.11 ²	0.02 ¹	-	-	-	-
RP 250 EC	-50 ... 200	0.05	Hybrid	2.5	-	-	1.50 ³	1.44 ³	1.20 ³	0.84 ³	0.54 ²	0.29 ²	0.11 ²	0.02 ¹	-	-	-	-
RP 290 E	-90 ... 200	0.05	Hybrid	2.5	-	-	0.80 ³	0.77 ³	0.74 ³	0.72 ³	0.70 ²	0.68 ²	0.64 ²	0.56 ²	0.39 ²	0.21 ²	0.09 ²	0.01 ¹
RP 290 EC	-90 ... 200	0.05	Hybrid	2.5	-	-	0.80 ³	0.77 ³	0.74 ³	0.72 ³	0.70 ²	0.68 ²	0.64 ²	0.56 ²	0.39 ²	0.21 ²	0.09 ²	0.01 ¹
LAUDA Integral T / Page 84																		
IN 130 T	-30 ... 120	0.05	Air	2.7	-	1.40	1.40	1.35	1.20	0.80	0.40	0.10	-	-	-	-	-	-
IN 230 T	-30 ... 120	0.05	Air	2.7	-	2.20	2.20	1.90	1.50	1.00	0.60	0.15	-	-	-	-	-	-
IN 230 TW	-30 ... 120	0.05	Water	2.7	-	2.30	2.30	2.30	1.90	1.30	0.75	0.35	-	-	-	-	-	-
IN 530 T	-30 ... 120	0.05	Air	8.0	-	5.00	5.00	4.50	3.80	2.60	1.50	0.60	-	-	-	-	-	-
IN 530 TW	-30 ... 120	0.05	Water	8.0	-	6.00	6.00	5.50	4.50	3.00	1.60	0.70	-	-	-	-	-	-
IN 1030 T	-30 ... 150	0.10	Air	8.0	-	11.00	11.00	9.50	7.10	4.90	3.00	1.60	-	-	-	-	-	-
IN 1330 TW	-30 ... 150	0.10	Water	16.0	-	13.00	13.00	10.00	7.60	5.40	3.40	1.70	-	-	-	-	-	-

¹Pump output step 2 ²Pump output step 4 ³Pump output step 8

Pump pressure max. bar	Pump flow max. pressure L/min	Pump connection thread mm	Bath volume min. L	Bath volume max. L	Dimensions (W x D x H) mm	Protection Rating	Noise level dB (A)	Weight kg	Loading max. kW	Power supply V; Hz	Cat. No.	Device type
0.8	2.6	Quick C. 1/4"	0.3	0.3	175×301×266	IP 21	57	6.9	0.2	100-240 V; 50/60 Hz	L000027	LOOP 100
0.8	2.6	Quick C. 1/4"	0.3	0.3	261×368×312	IP 21	57	11.9	0.4	100-240 V; 50/60 Hz	L000580	LOOP 250
0.7	22	M16×1	2.4	4.4	250×365×425	IP 21	47	15.5	2.7	200-230 V; 50/60 Hz	L000019	P 2 E
0.7	22	M16×1	2.4	4.4	250×365×425	IP 21	47	15.5	2.7	200-230 V; 50/60 Hz	L000020	P 2 EC
0.7	22	M16×1	2.4	4.4	300×430×675	IP 21	54	46.0	3.7	230 V; 50 Hz	L000021	RP 240 E
0.7	22	M16×1	2.4	4.4	300×430×675	IP 21	54	46.0	3.7	230 V; 50 Hz	L000023	RP 240 EC
0.7	22	M16×1	2.4	4.4	300×430×675	IP 21	54	46.0	3.7	230 V; 50 Hz	L000022	RP 245 E
0.7	22	M16×1	2.4	4.4	300×430×675	IP 21	54	46.0	3.7	230 V; 50 Hz	L000024	RP 245 EC
0.7	22	M16×1	2.4	4.4	300×430×675	IP 21	57	47.0	3.7	230 V; 50 Hz	L002494	RP 250 E
0.7	22	M16×1	2.4	4.4	300×430×675	IP 21	57	47.0	3.7	230 V; 50 Hz	L002495	RP 250 EC
0.7	22	M16×1	2.4	4.4	390×600×685	IP 21	56	79.0	3.7	230 V; 50 Hz	L002502	RP 290 E
0.7	22	M16×1	2.4	4.4	390×600×685	IP 21	56	79.0	3.7	230 V; 50 Hz	L002503	RP 290 EC
3.5	40	G 3/4	3.6	8.7	430×550×760	IP 21	61	76.0	3.7	230 V; 50 Hz	L002663	IN 130 T
3.5	40	G 3/4	3.6	8.7	430×550×760	IP 21	63	80.0	3.7	230 V; 50 Hz	L002664	IN 230 T
3.5	40	G 3/4	3.6	8.7	430×550×760	IP 21	58	82.0	3.7	230 V; 50 Hz	L002665	IN 230 TW
3.5	40	G 3/4	7.2	20.5	560×550×1325	IP 21	62	146.0	11.0	400 V; 3/PE; 50 Hz & 460 V; 3/PE; 60 Hz	L002666	IN 530 T
3.5	40	G 3/4	7.2	20.5	560×550×1325	IP 21	62	148.0	11.0	400 V; 3/PE; 50 Hz & 460 V; 3/PE; 60 Hz	L002667	IN 530 TW
5.5	60	M38×1,5	9.7	25.5	760×650×1605	IP 21	69	212.0	20.0	400 V; 3/PE; 50 Hz & 460 V; 3/PE; 60 Hz	L002668	IN 1030 T
5.5	60	M38×1,5	9.7	25.5	760×650×1605	IP 21	59	214.0	20.0	400 V; 3/PE; 50 Hz & 460 V; 3/PE; 60 Hz	L002669	IN 1330 TW

LAUDA Circulation and process thermostats

Technical data according to DIN 12876 standard

Device type	Working temperature range °C	Temperature stability ±K	Cooling of the refrigerating machine	Heater power max. kW	Cooling output kW													
					200 °C	100 °C	20 °C	10 °C	0 °C	-10 °C	-20 °C	-30 °C	-40 °C	-50 °C	-60 °C	-70 °C	-80 °C	-90 °C
LAUDA Integral XT / Page 86																		
IN 150 XT	-45 ... 220	0.05	Air	3.5	1.50 ³	1.50 ³	1.50 ³	1.50 ³	1.30 ³	1.00 ³	0.70 ²	0.30 ²	0.06 ²	-	-	-	-	-
IN 250 XTW	-45 ... 220	0.05	Water	3.5	2.20 ³	2.20 ³	2.10 ³	2.00 ³	1.80 ³	1.40 ³	1.00 ²	0.55 ²	0.20 ²	-	-	-	-	-
IN 550 XT	-50 ... 220	0.05	Air	8.0	5.00 ³	5.00 ³	5.00 ³	4.80 ³	4.60 ³	3.30 ³	2.30 ²	1.20 ²	0.50 ²	0.10 ¹	-	-	-	-
IN 550 XTW	-50 ... 220	0.05	Water	8.0	5.80 ³	5.80 ³	5.80 ³	5.80 ³	5.40 ³	4.00 ³	2.60 ²	1.45 ²	0.55 ²	0.12 ¹	-	-	-	-
IN 750 XT	-45 ... 220	0.05	Air	8.0	7.00 ³	7.00 ³	7.00 ³	7.00 ³	5.40 ³	3.60 ³	2.60 ²	1.60 ²	0.80 ²	-	-	-	-	-
IN 950 XTW	-50 ... 220	0.05	Water	8.0	9.50 ³	9.50 ³	9.50 ³	8.50 ³	6.20 ³	4.30 ³	3.00 ²	1.70 ²	0.90 ²	0.35 ¹	-	-	-	-
IN 1850 XTW	-50 ... 220	0.05	Water	16.0	20.00 ³	20.00 ³	20.00 ³	15.00 ³	11.50 ³	8.50 ³	6.10 ²	3.60 ²	1.90 ²	1.10 ¹	-	-	-	-
IN 280 XT	-80 ... 220	0.05	Air	4.0	1.60 ³	1.60 ³	1.60 ³	1.55 ³	1.50 ³	1.50 ³	1.70 ²	1.70 ²	1.65 ²	1.40 ²	0.85 ²	0.35 ²	0.15 ²	-
IN 280 XTW	-80 ... 220	0.05	Water	4.0	1.70 ³	1.70 ³	1.70 ³	1.65 ³	1.60 ³	1.60 ³	1.80 ²	1.80 ²	1.80 ²	1.50 ²	0.90 ²	0.45 ²	0.18 ²	-
IN 590 XTW	-90 ... 220	0.05	Water	8.0	4.50 ³	4.50 ³	4.50 ³	4.45 ³	4.40 ³	4.40 ³	4.60 ²	4.60 ²	4.50 ²	4.20 ²	2.70 ²	1.40 ²	0.60 ²	0.20 ¹
IN 1590 XTW	-90 ... 220	0.05	Water	12.0	18.50 ³	18.50 ³	18.50 ³	15.00 ³	11.50 ³	8.70 ³	8.50 ²	8.50 ²	7.50 ²	6.00 ²	4.00 ²	2.20 ²	0.90 ²	0.35 ¹
XT 4 H	80 ... 320	0.05		3.6	-	-	-	-	-	-	-	-	-	-	-	-	-	-
XT 4 HW	30 ... 320	0.10	Water	3.6	16.00 ²	9.00 ²	-	-	-	-	-	-	-	-	-	-	-	-
XT 8 H	80 ... 320	0.05		8.0	-	-	-	-	-	-	-	-	-	-	-	-	-	-
XT 8 HW	30 ... 320	0.10	Water	8.0	16.00 ²	9.00 ²	-	-	-	-	-	-	-	-	-	-	-	-
LAUDA Variocool / Page 88																		
VC 1200	-20 ... 80	0.05	Air	1.5	-	-	1.20	1.00	0.70	0.40	0.14	-	-	-	-	-	-	-
VC 1200	-20 ... 80	0.05	Air	2.3	-	-	1.20	1.00	0.70	0.40	0.14	-	-	-	-	-	-	-
VC 1200	-20 ... 80	0.05	Air	2.3	-	-	1.12	0.92	0.62	0.32	0.06	-	-	-	-	-	-	-
VC 1200	-20 ... 80	0.05	Air	1.5	-	-	1.12	0.92	0.62	0.32	0.06	-	-	-	-	-	-	-
VC 1200	-20 ... 80	0.05	Air	1.5	-	-	1.00	0.80	0.50	0.20	0.01	-	-	-	-	-	-	-
VC 1200	-20 ... 80	0.05	Air	2.3	-	-	1.00	0.80	0.50	0.20	0.01	-	-	-	-	-	-	-

¹Pump output step 2 ²Pump output step 4 ³Pump output step 8

Pump pressure max. bar	Pump flow max. pressure L/min	Pump connection thread mm	Bath volume min. L	Bath volume max. L	Dimensions (W x D x H) mm	Protection Rating	Noise level dB (A)	Weight kg	Loading max. kW	Power supply V; Hz	Cat. No.	Device type
3.1	65	M30×1,5	2.5	8.7	430×550×760	IP 21	60	103.0	3.7	230 V; 50 Hz	L002673	IN 150 XT
3.1	65	M30×1,5	2.5	8.7	430×550×760	IP 21	57	105.0	3.7	230 V; 50 Hz	L002674	IN 250 XTW
3.1	65	M30×1,5	4.8	17.2	560×550×1325	IP 21	65	171.0	12.0	400 V; 3/PE; 50 Hz & 460 V; 3/PE; 60 Hz	L002675	IN 550 XT
3,1	65	M30×1,5	4.8	17.2	560×550×1325	IP 21	62	176.0	12.0	400 V; 3/PE; 50 Hz & 460 V; 3/PE; 60 Hz	L002676	IN 550 XTW
3.1	65	M30×1,5	4.8	17.2	560×550×1325	IP 21	66	169.0	12.0	400 V; 3/PE; 50 Hz & 460 V; 3/PE; 60 Hz	L002677	IN 750 XT
3.1	65	M30×1,5	4.8	17.2	560×550×1325	IP 21	67	173.0	12.0	400 V; 3/PE; 50 Hz & 460 V; 3/PE; 60 Hz	L002678	IN 950 XTW
6.0	120	M38×1,5	8.0	28.6	760×650×1605	IP 21	62	272.0	20.0	400 V; 3/PE; 50 Hz & 460 V; 3/PE; 60 Hz	L002680	IN 1850 XTW
3.1	65	M30×1,5	4.8	17.2	560×550×1325	IP 21	62	183.0	9.0	400 V; 3/PE; 50 Hz & 460 V; 3/PE; 60 Hz	L002684	IN 280 XT
3.1	65	M30×1,5	4.8	17.2	560×550×1325	IP 21	60	187.0	9.0	400 V; 3/PE; 50 Hz & 460 V; 3/PE; 60 Hz	L002685	IN 280 XTW
3.1	65	M30×1,5	8.0	28.6	760×650×1605	IP 21	61	274.0	12.0	400 V; 3/PE; 50 Hz & 460 V; 3/PE; 60 Hz	L002687	IN 590 XTW
3.1	65	M38×1,5	10.0	30.6	760×650×1605	IP 21	63	345.0	25.0	400 V; 3/PE; 50 Hz & 460 V; 3/PE; 60 Hz	L002689	IN 1590 XTW
2.9	45	M30×1,5	2.6	8.1	335×550×660	IP 21C	51	60.0	3.7	230 V; 50 Hz	L001839	XT 4 H
2.9	45	M30×1,5	2.6	8.1	335×550×660	IP 21C	51	64.0	3.7	230 V; 50 Hz	L001840	XT 4 HW
2.9	45	M30×1,5	2.6	8.1	335×550×660	IP 21C	51	62.0	8.7	400 V; 3/PE; 50 Hz	L001845	XT 8 H
2.9	45	M30×1,5	2.6	8.1	335×550×660	IP 21C	51	66.0	8.7	400 V; 3/PE; 50 Hz	L001846	XT 8 HW
0.9	28	G 3/4	8.0	15.0	450×550×650	IP 32	51	54.0	2.6	230 V; 50 Hz	L000711	VC 1200
0.9	28	G 3/4	8.0	15.0	450×550×650	IP 32	51	54.0	3.3	230 V; 50 Hz	L000712	VC 1200
3.2	37	G 3/4	8.0	15.0	450×550×790	IP 32	53	54.0	3.3	230 V; 50 Hz	L000923	VC 1200
3.2	37	G 3/4	8.0	15.0	450×550×790	IP 32	53	54.0	2.6	230 V; 50 Hz	L000921	VC 1200
4.8	37	G 3/4	8.0	15.0	450×550×790	IP 32	57	54.0	2.6	230 V; 50 Hz	L000922	VC 1200
4.8	37	G 3/4	8.0	15.0	450×550×790	IP 32	57	54.0	3.3	230 V; 50 Hz	L000924	VC 1200

LAUDA Circulation and process thermostats

Technical data according to DIN 12876 standard

Device type	Working temperature range °C	Temperature stability ±K	Cooling of the refrigerating machine	Heater power max. kW	Cooling output kW													
					200 °C	100 °C	20 °C	10 °C	0 °C	-10 °C	-20 °C	-30 °C	-40 °C	-50 °C	-60 °C	-70 °C	-80 °C	-90 °C
LAUDA Variocool / Page 88																		
VC 1200 W	-20 ... 80	0.05	Water	2.3	-	-	1.20	1.00	0.70	0.40	0.14	-	-	-	-	-	-	-
VC 1200 W	-20 ... 80	0.05	Water	1.5	-	-	1.20	1.00	0.70	0.40	0.14	-	-	-	-	-	-	-
VC 1200 W	-20 ... 80	0.05	Water	1.5	-	-	1.12	0.92	0.62	0.32	0.06	-	-	-	-	-	-	-
VC 1200 W	-20 ... 80	0.05	Water	2.3	-	-	1.12	0.92	0.62	0.32	0.06	-	-	-	-	-	-	-
VC 1200 W	-20 ... 80	0.05	Water	1.5	-	-	1.00	0.80	0.50	0.20	0.01	-	-	-	-	-	-	-
VC 1200 W	-20 ... 80	0.05	Water	2.3	-	-	1.00	0.80	0.50	0.20	0.01	-	-	-	-	-	-	-
VC 2000	-20 ... 80	0.05	Air	1.5	-	-	2.00	1.50	1.06	0.68	0.38	-	-	-	-	-	-	-
VC 2000	-20 ... 80	0.05	Air	2.2	-	-	2.00	1.50	1.06	0.68	0.38	-	-	-	-	-	-	-
VC 2000	-20 ... 80	0.05	Air	1.5	-	-	1.92	1.42	0.98	0.60	0.30	-	-	-	-	-	-	-
VC 2000	-20 ... 80	0.05	Air	2.2	-	-	1.92	1.42	0.98	0.60	0.30	-	-	-	-	-	-	-
VC 2000	-20 ... 80	0.05	Air	2.2	-	-	1.80	1.30	0.86	0.48	0.18	-	-	-	-	-	-	-
VC 2000	-20 ... 80	0.05	Air	1.5	-	-	1.80	1.30	0.86	0.48	0.18	-	-	-	-	-	-	-
VC 2000 W	-20 ... 80	0.05	Water	1.5	-	-	2.00	1.50	1.06	0.68	0.38	-	-	-	-	-	-	-
VC 2000 W	-20 ... 80	0.05	Water	2.2	-	-	2.00	1.50	1.06	0.68	0.38	-	-	-	-	-	-	-
VC 2000 W	-20 ... 80	0.05	Water	1.5	-	-	1.92	1.42	0.98	0.60	0.30	-	-	-	-	-	-	-
VC 2000 W	-20 ... 80	0.05	Water	2.2	-	-	1.92	1.42	0.98	0.60	0.30	-	-	-	-	-	-	-
VC 2000 W	-20 ... 80	0.05	Water	1.5	-	-	1.80	1.30	0.86	0.48	0.18	-	-	-	-	-	-	-
VC 2000 W	-20 ... 80	0.05	Water	2.2	-	-	1.80	1.30	0.86	0.48	0.18	-	-	-	-	-	-	-
VC 3000	-20 ... 80	0.05	Air	1.5	-	-	3.00	2.40	1.68	0.95	0.45	-	-	-	-	-	-	-
VC 3000	-20 ... 80	0.05	Air	1.5	-	-	2.80	2.20	1.48	0.75	0.25	-	-	-	-	-	-	-
VC 3000 W	-20 ... 80	0.05	Water	1.5	-	-	3.00	2.40	1.68	0.95	0.45	-	-	-	-	-	-	-
VC 3000 W	-20 ... 80	0.05	Water	1.5	-	-	2.80	2.20	1.48	0.75	0.25	-	-	-	-	-	-	-
VC 5000	-20 ... 80	0.05	Air	4.5	-	-	5.00	3.90	2.75	1.70	0.90	-	-	-	-	-	-	-
VC 5000	-20 ... 80	0.05	Air	4.5	-	-	4.50	3.40	2.25	1.20	0.40	-	-	-	-	-	-	-
VC 5000	-20 ... 80	0.05	Air	4.5	-	-	4.65	3.55	2.40	1.35	0.55	-	-	-	-	-	-	-
VC 5000 W	-20 ... 80	0.05	Water	4.5	-	-	5.00	3.90	2.75	1.70	0.90	-	-	-	-	-	-	-
VC 5000 W	-20 ... 80	0.05	Water	4.5	-	-	4.50	3.40	2.25	1.20	0.40	-	-	-	-	-	-	-
VC 5000 W	-20 ... 80	0.05	Water	4.5	-	-	4.65	3.55	2.40	1.35	0.55	-	-	-	-	-	-	-

Pump pressure max. bar	Pump flow max. pressure L/min	Pump connection thread mm	Bath volume min. L	Bath volume max. L	Dimensions (W x D x H) mm	Protection Rating	Noise level dB (A)	Weight kg	Loading max. kW	Power supply V; Hz	Cat. No.	Device type
0.9	28	G 3/4	8.0	15.0	450×550×650	IP 32	50	51.0	3.3	230 V; 50 Hz	L000732	VC 1200 W
0.9	28	G 3/4	8.0	15.0	450×550×650	IP 32	50	51.0	2.6	230 V; 50 Hz	L000731	VC 1200 W
3.2	37	G 3/4	8.0	15.0	450×550×790	IP 32	52	51.0	2.6	230 V; 50 Hz	L000954	VC 1200 W
3.2	37	G 3/4	8.0	15.0	450×550×790	IP 32	52	51.0	3.3	230 V; 50 Hz	L000956	VC 1200 W
4.8	37	G 3/4	8.0	15.0	450×550×790	IP 32	56	51.0	2.6	230 V; 50 Hz	L000955	VC 1200 W
4.8	37	G 3/4	8.0	15.0	450×550×790	IP 32	56	51.0	3.3	230 V; 50 Hz	L000957	VC 1200 W
0.9	28	G 3/4	8.0	15.0	450×550×650	IP 32	52	57.0	2.6	230 V; 50 Hz	L000713	VC 2000
0.9	28	G 3/4	8.0	15.0	450×550×650	IP 32	52	57.0	3.3	230 V; 50 Hz	L000714	VC 2000
3.2	37	G 3/4	8.0	15.0	450×550×790	IP 32	56	57.0	2.6	230 V; 50 Hz	L000925	VC 2000
3.2	37	G 3/4	8.0	15.0	450×550×790	IP 32	56	57.0	3.3	230 V; 50 Hz	L000927	VC 2000
4.8	37	G 3/4	8.0	15.0	450×550×790	IP 32	58	57.0	3.3	230 V; 50 Hz	L000928	VC 2000
4.8	37	G 3/4	8.0	15.0	450×550×790	IP 32	58	57.0	2.6	230 V; 50 Hz	L000926	VC 2000
0.9	28	G 3/4	8.0	15.0	450×550×650	IP 32	50	54.0	2.6	230 V; 50 Hz	L000733	VC 2000 W
0.9	28	G 3/4	8.0	15.0	450×550×650	IP 32	50	54.0	3.3	230 V; 50 Hz	L000734	VC 2000 W
3.2	37	G 3/4	8.0	15.0	450×550×790	IP 32	53	54.0	2.6	230 V; 50 Hz	L000958	VC 2000 W
3.2	37	G 3/4	8.0	15.0	450×550×790	IP 32	53	54.0	3.3	230 V; 50 Hz	L000960	VC 2000 W
4.8	37	G 3/4	8.0	15.0	450×550×790	IP 32	56	54.0	2.6	230 V; 50 Hz	L000959	VC 2000 W
4.8	37	G 3/4	8.0	15.0	450×550×790	IP 32	56	54.0	3.3	230 V; 50 Hz	L000961	VC 2000 W
3.2	37	G 3/4	20.0	33.0	550×650×970	IP 32	57	93.0	2.6	230 V; 50 Hz	L000715	VC 3000
4.8	37	G 3/4	20.0	33.0	550×650×970	IP 32	61	93.0	2.6	230 V; 50 Hz	L000929	VC 3000
3.2	37	G 3/4	20.0	33.0	550×650×970	IP 32	55	89.0	2.6	230 V; 50 Hz	L000735	VC 3000 W
4.8	37	G 3/4	20.0	33.0	550×650×970	IP 32	59	89.0	2.6	230 V; 50 Hz	L000962	VC 3000 W
3.2	37	G 3/4	20.0	33.0	550×650×970	IP 32	65	98.0	7.8	400 V; 3/N/PE; 50 Hz	L000728	VC 5000
4.8	37	G 3/4	20.0	33.0	550×650×970	IP 32	69	98.0	7.8	400 V; 3/N/PE; 50 Hz	L000948	VC 5000
5.0	60	G 3/4	20.0	33.0	550×650×970	IP 32	69	98.0	7.8	400 V; 3/N/PE; 50 Hz	L000949	VC 5000
3.2	37	G 3/4	20.0	33.0	550×650×970	IP 32	64	94.0	7.8	400 V; 3/N/PE; 50 Hz	L000746	VC 5000 W
4.8	37	G 3/4	20.0	33.0	550×650×970	IP 32	68	94.0	7.8	400 V; 3/N/PE; 50 Hz	L000981	VC 5000 W
5.0	60	G 3/4	20.0	33.0	550×650×970	IP 32	68	94.0	7.8	400 V; 3/N/PE; 50 Hz	L001995	VC 5000 W

LAUDA Circulation and process thermostats

Technical data according to DIN 12876 standard

Device type	Working temperature range °C	Temperature stability ±K	Cooling of the refrigerating machine	Heater power max. kW	Cooling output kW													
					200 °C	100 °C	20 °C	10 °C	0 °C	-10 °C	-20 °C	-30 °C	-40 °C	-50 °C	-60 °C	-70 °C	-80 °C	-90 °C

LAUDA Variocool / Page 88

VC 7000	-20 ... 80	0.10	Air	4.5	-	-	7.00	5.30	3.70	2.40	1.30	-	-	-	-	-	-	-
VC 7000	-20 ... 80	0.10	Air	4.5	-	-	6.50	4.80	3.20	1.90	0.80	-	-	-	-	-	-	-
VC 7000	-20 ... 80	0.10	Air	4.5	-	-	6.65	4.95	3.35	2.05	0.95	-	-	-	-	-	-	-
VC 7000 W	-20 ... 80	0.10	Water	4.5	-	-	7.00	5.30	3.70	2.40	1.30	-	-	-	-	-	-	-
VC 7000 W	-20 ... 80	0.10	Water	4.5	-	-	6.50	4.80	3.20	1.90	0.80	-	-	-	-	-	-	-
VC 7000 W	-20 ... 80	0.10	Water	4.5	-	-	6.65	4.95	3.35	2.05	0.95	-	-	-	-	-	-	-
VC 10000	-20 ... 80	0.10	Air	7.5	-	-	10.00	7.60	5.30	3.50	2.00	-	-	-	-	-	-	-
VC 10000	-20 ... 80	0.10	Air	7.5	-	-	9.50	7.10	4.80	3.00	1.50	-	-	-	-	-	-	-
VC 10000	-20 ... 80	0.10	Air	7.5	-	-	9.65	7.25	4.95	3.15	1.65	-	-	-	-	-	-	-
VC 10000 W	-20 ... 80	0.10	Water	7.5	-	-	10.00	7.60	5.30	3.50	2.00	-	-	-	-	-	-	-
VC 10000 W	-20 ... 80	0.10	Water	7.5	-	-	9.50	7.10	4.80	3.00	1.50	-	-	-	-	-	-	-
VC 10000 W	-20 ... 80	0.10	Water	7.5	-	-	9.65	7.25	4.95	3.15	1.65	-	-	-	-	-	-	-

LAUDA Kryoheater Selecta / Page 90

KHS 3560 W	-60 ... 200	0.50	Water	18.0	35.00	-	35.00	32.00	30.00	29.00	18.00	14.00	10.00	6.00	2.50	-	-	-
KHS 2190 W	-90 ... 200	0.50	Water	18.0	21.00	-	21.00	20.00	18.00	15.00	11.00	10.50	10.00	9.50	9.00	6.30	3.50	1.00

LAUDA-Noah Semistat / Page 92

S 1200	-20 ... 90	0.10	Water	-	-	-	1.20	0.90	0.60	0.35	0.08	-	-	-	-	-	-	-
S 2400	-20 ... 90	0.10	Water	-	-	-	2.45	1.93	1.40	0.88	0.20	-	-	-	-	-	-	-
S 4400	-20 ... 90	0.10	Water	-	-	-	4.40	3.50	2.60	1.65	0.70	-	-	-	-	-	-	-

Pump pressure max. bar	Pump flow max. pressure L/min	Pump connection thread mm	Bath volume min. L	Bath volume max. L	Dimensions (W x D x H) mm	Protection Rating	Noise level dB (A)	Weight kg	Loading max. kW	Power supply V; Hz	Cat. No.	Device type
3.2	37	G 1 1/4	48.0	64.0	650×670×1250	IP 32	66	138.0	8.8	400 V; 3/N/PE; 50 Hz	L000729	VC 7000
4.8	37	G 1 1/4	48.0	64.0	650×670×1250	IP 32	69	138.0	8.8	400 V; 3/N/PE; 50 Hz	L000950	VC 7000
5.0	60	G 1 1/4	48.0	64.0	650×670×1250	IP 32	69	138.0	8.8	400 V; 3/N/PE; 50 Hz	L000951	VC 7000
3.2	37	G 1 1/4	48.0	64.0	650×670×1250	IP 32	60	131.0	8.8	400 V; 3/N/PE; 50 Hz	L000747	VC 7000 W
4.8	37	G 1 1/4	48.0	64.0	650×670×1250	IP 32	64	131.0	8.8	400 V; 3/N/PE; 50 Hz	L000982	VC 7000 W
5.0	60	G 1 1/4	48.0	64.0	650×670×1250	IP 32	64	131.0	8.8	400 V; 3/N/PE; 50 Hz	L000983	VC 7000 W
3.2	37	G 1 1/4	48.0	64.0	650×670×1250	IP 32	67	147.0	11.1	400 V; 3/N/PE; 50 Hz	L000730	VC 10000
4.8	37	G 1 1/4	48.0	64.0	650×670×1250	IP 32	70	147.0	11.1	400 V; 3/N/PE; 50 Hz	L000952	VC 10000
5.0	60	G 1 1/4	48.0	64.0	650×670×1250	IP 32	70	147.0	11.1	400 V; 3/N/PE; 50 Hz	L000953	VC 10000
3.2	37	G 1 1/4	48.0	64.0	650×670×1250	IP 32	61	140.0	11.1	400 V; 3/N/PE; 50 Hz	L000748	VC 10000 W
4.8	37	G 1 1/4	48.0	64.0	650×670×1250	IP 32	65	140.0	11.1	400 V; 3/N/PE; 50 Hz	L000984	VC 10000 W
5.0	60	G 1 1/4	48.0	64.0	650×670×1250	IP 32	65	140.0	11.1	400 V; 3/N/PE; 50 Hz	L000985	VC 10000 W
5.5	85	DN 25	15.0	55.0	920×1200×1700	IP 54	68	850.0	29.5	400 V; 3/PE; 50 Hz	L001984	KHS 3560 W
5.5	85	DN 25	15.0	55.0	920×1200×1700	IP 54	68	890.0	32.8	400 V; 3/PE; 50 Hz	L001989	KHS 2190 W
2.8	22	1/2"	1.00	1.30	116×232×470	-	-	15	-	-	-	S 1200
2.8	22	1/2"	1.25	1.60	116×300×560	-	-	25	-	-	-	S 2400
2.8	27	1/2"	2.50	2.80	194×300×560	-	-	38	-	-	-	S 4400

LAUDA Circulation and process thermostats

Power supply variants

Device type	Power supply V; Hz	Heater power max. kW	Pump pressure max. bar	Pump flow max. pressure L /min	Loading max. kW	Plug code*	Cat. No.	Device type	Power supply V; Hz	Heater power max. kW	Pump pressure max. bar	Pump flow max. pressure L /min	Loading max. kW	Plug code*	Cat. No.
LAUDA PRO / Page 82															
P 2 E	100-120 V; 50/60 Hz	1.8	0.7	22.0	1.9	32	L000557	RP 245 E	100 V; 50/60 Hz	1.3	0.7	22.0	1.6	32	L000541
P 2 E	100-120 V; 50/60 Hz	1.8	0.7	22.0	1.9	4	L000549	RP 245 E	100 V; 50/60 Hz	1.3	0.7	22.0	1.5	14	L000533
P 2 EC	100-120 V; 50/60 Hz	1.8	0.7	22.0	1.9	32	L000561	RP 245 E	120 V; 60 Hz	1.8	0.7	22.0	1.9	32	L000461
P 2 EC	100-120 V; 50/60 Hz	1.8	0.7	22.0	1.9	4	L000553	RP 245 E	120 V; 60 Hz	1.8	0.7	22.0	1.9	4	L000453
RP 240 E	100 V; 50/60 Hz	1.3	0.7	22.0	1.6	32	L000540	RP 245 E	200 V; 50/60 Hz	1.9	0.7	22.0	3.2	32	L000521
RP 240 E	100 V; 50/60 Hz	1.3	0.7	22.0	1.5	14	L000532	RP 245 E	200 V; 50/60 Hz	1.9	0.7	22.0	3.2	31	L000505
RP 240 E	120 V; 60 Hz	1.8	0.7	22.0	1.9	32	L000460	RP 245 E	200 V; 50/60 Hz	1.9	0.7	22.0	3.2	3	L000489
RP 240 E	120 V; 60 Hz	1.8	0.7	22.0	1.9	4	L000452	RP 245 E	208-220 V; 60 Hz	2.3	0.7	22.0	3.5	31	L000425
RP 240 E	200 V; 50/60 Hz	1.9	0.7	22.0	3.2	3	L000488	RP 245 E	208-220 V; 60 Hz	2.3	0.7	22.0	3.5	3	L000313
RP 240 E	200 V; 50/60 Hz	1.9	0.7	22.0	3.2	32	L000520	RP 245 E	208-220 V; 60 Hz	2.3	0.7	22.0	3.5	32	L000441
RP 240 E	200 V; 50/60 Hz	1.9	0.7	22.0	3.2	31	L000504	RP 245 EC	100 V; 50/60 Hz	1.3	0.7	22.0	1.6	32	L000545
RP 240 E	208-220 V; 60 Hz	2.3	0.7	22.0	3.5	32	L000440	RP 245 EC	100 V; 50/60 Hz	1.3	0.7	22.0	1.5	14	L000537
RP 240 E	208-220 V; 60 Hz	2.3	0.7	22.0	3.5	3	L000312	RP 245 EC	120 V; 60 Hz	1.8	0.7	22.0	1.9	4	L000457
RP 240 E	208-220 V; 60 Hz	2.3	0.7	22.0	3.5	31	L000424	RP 245 EC	120 V; 60 Hz	1.8	0.7	22.0	1.9	32	L000465
RP 240 EC	100 V; 50/60 Hz	1.3	0.7	22.0	1.6	32	L000544	RP 245 EC	200 V; 50/60 Hz	1.9	0.7	22.0	3.2	32	L000529
RP 240 EC	100 V; 50/60 Hz	1.3	0.7	22.0	1.5	14	L000536	RP 245 EC	200 V; 50/60 Hz	1.9	0.7	22.0	3.2	31	L000513
RP 240 EC	120 V; 60 Hz	1.8	0.7	22.0	1.9	32	L000464	RP 245 EC	200 V; 50/60 Hz	1.9	0.7	22.0	3.2	3	L000497
RP 240 EC	120 V; 60 Hz	1.8	0.7	22.0	1.9	4	L000456	RP 245 EC	208-220 V; 60 Hz	2.3	0.7	22.0	3.5	3	L000321
RP 240 EC	200 V; 50/60 Hz	1.9	0.7	22.0	3.2	31	L000512	RP 245 EC	208-220 V; 60 Hz	2.3	0.7	22.0	3.5	32	L000449
RP 240 EC	200 V; 50/60 Hz	1.9	0.7	22.0	3.2	3	L000496	RP 245 EC	208-220 V; 60 Hz	2.3	0.7	22.0	3.5	31	L000433
RP 240 EC	200 V; 50/60 Hz	1.9	0.7	22.0	3.2	32	L000528	RP 250 E	200 V; 50/60 Hz	1.9	0.7	22.0	3.2	3	L002498
RP 240 EC	208-220 V; 60 Hz	2.3	0.7	22.0	3.5	32	L000448	RP 250 EC	200 V; 50/60 Hz	1.9	0.7	22.0	3.2	3	L002499
RP 240 EC	208-220 V; 60 Hz	2.3	0.7	22.0	3.5	3	L000320	RP 290 E	200 V; 50/60 Hz	1.9	0.7	22.0	3.2	3	L002506
RP 240 EC	208-220 V; 60 Hz	2.3	0.7	22.0	3.5	31	L000432	RP 290 EC	200 V; 50/60 Hz	1.9	0.7	22.0	3.2	3	L002507

*All data for the plug codes can be found on page 150

Device type	Power supply V; Hz	Heater power max. kW	Pump pressure max. bar	Pump flow max. pressure L /min	Loading max. kW	Plug code*	Cat. No.	Device type	Power supply V; Hz	Heater power max. kW	Pump pressure max. bar	Pump flow max. pressure L /min	Loading max. kW	Plug code*	Cat. No.
-------------	--------------------	----------------------	------------------------	--------------------------------	-----------------	------------	----------	-------------	--------------------	----------------------	------------------------	--------------------------------	-----------------	------------	----------

LAUDA Integral T / Page 84

IN 230 T	200 V; 50/60 Hz	2.2	3.5	40.0	3.2	3	L002789	IN 130 T	208-220 V; 60 Hz	2.6	4.0	45.0	3.5	3	L002788
IN 230 TW	200 V; 50/60 Hz	2.2	3.5	40.0	3.2	3	L002790	IN 1030 T	400 V; 3/PE; 50 Hz & 460 V; 3/PE; 60 Hz	8.0	5.5	60.0	20.0	33	L002885
IN 130 T	200 V; 50/60 Hz	2.2	3.5	40.0	3.2	3	L002787	IN 1330 TW	400 V; 3/PE; 50 Hz & 460 V; 3/PE; 60 Hz	16.0	5.5	60.0	20.0	33	L002886
IN 230 TW	208-220 V; 60 Hz	2.6	4.0	45.0	3.5	3	L002792	IN 530 T	400 V; 3/PE; 50 Hz & 460 V; 3/PE; 60 Hz	8.0	3.5	40.0	11.0	34	L002883
IN 230 T	208-220 V; 60 Hz	2.6	4.0	45.0	3.5	3	L002791	IN 530 TW	400 V; 3/PE; 50 Hz & 460 V; 3/PE; 60 Hz	8.0	3.5	40.0	11.0	34	L002884

LAUDA Integral XT / Page 86

IN 250 XTW	200 V; 50/60 Hz	3.1	3.1	65.0	3.2	3	L002795	IN 590 XTW	400 V; 3/PE; 50 Hz & 460 V; 3/PE; 60 Hz	8.0	3.1	65.0	12.0	34	L002897
IN 150 XT	200 V; 50/60 Hz	3.0	3.1	65.0	3.2	3	L002793	IN 280 XT	400 V; 3/PE; 50 Hz & 460 V; 3/PE; 60 Hz	4.0	3.1	65.0	9.0	34	L002892
IN 250 XTW	208-220 V; 60 Hz	3.4	3.1	65.0	3.5	3	L002796	XT 4 H	200 V; 50/60 Hz	2.7	2.9	45.0	3.2	3	L001851
IN 150 XT	208-220 V; 60 Hz	3.3	3.1	65.0	3.5	3	L002794	XT 4 H	208-220 V; 60 Hz	3.2	2.9	45.0	3.6	3	L001847
IN 750 XT	400 V; 3/PE; 50 Hz & 460 V; 3/PE; 60 Hz	8.0	3.1	65.0	12.0	34	L002889	XT 4 HW	200 V; 50/60 Hz	2.7	2.9	45.0	3.2	3	L001852
IN 550 XT	400 V; 3/PE; 50 Hz & 460 V; 3/PE; 60 Hz	8.0	3.1	65.0	12.0	34	L002887	XT 4 HW	208-220 V; 60 Hz	3.2	2.9	45.0	3.6	3	L001848
IN 280 XTW	400 V; 3/PE; 50 Hz & 460 V; 3/PE; 60 Hz	4.0	3.1	65.0	9.0	34	L002893	XT 8 H	200 V; 3/PE; 50/60 Hz	8.0	2.9	45.0	8.7	31	L001853
IN 550 XTW	400 V; 3/PE; 50 Hz & 460 V; 3/PE; 60 Hz	8.0	3.1	65.0	12.0	34	L002888	XT 8 H	208-220 V; 3/PE; 60 Hz	8.0	2.9	45.0	8.7	31	L001849
IN 1590 XTW	400 V; 3/PE; 50 Hz & 460 V; 3/PE; 60 Hz	12.0	3.1	65.0	25.0	33	L002898	XT 8 HW	200 V; 3/PE; 50/60 Hz	8.0	2.9	45.0	8.7	31	L001854
IN 1850 XTW	400 V; 3/PE; 50 Hz & 460 V; 3/PE; 60 Hz	16.0	6.0	120.0	20.0	33	L002895	XT 8 HW	208-220 V; 3/PE; 60 Hz	8.0	2.9	45.0	8.7	31	L001850

LAUDA Circulation and process thermostats

Power supply variants

Device type	Power supply V; Hz	Heater power max. kW	Pump pressure max. bar	Pump flow max. pressure L./min	Loading max. kW	Plug code*	Cat. No.	Device type	Power supply V; Hz	Heater power max. kW	Pump pressure max. bar	Pump flow max. pressure L./min	Loading max. kW	Plug code*	Cat. No.
LAUDA Variocool / Page 88															
VC 1200	200 V; 50/60 Hz	1.1	0.9	28.0	2.3	3	L000768	VC 2000	208-220 V; 60 Hz	1.3	3.2	37.0	2.5	3	L000990
VC 1200	200 V; 50/60 Hz	1.7	0.9	28.0	2.9	3	L000769	VC 2000	208-220 V; 60 Hz	2.1	3.2	37.0	3.2	3	L000992
VC 1200	200 V; 50/60 Hz	1.7	3.2	37.0	2.9	3	L001018	VC 2000	208-220 V; 60 Hz	1.3	4.8	37.0	2.5	3	L000991
VC 1200	200 V; 50/60 Hz	1.1	3.2	37.0	2.3	3	L001016	VC 2000	208-220 V; 60 Hz	2.1	4.8	37.0	3.2	3	L000993
VC 1200	200 V; 50/60 Hz	1.7	4.8	37.0	2.9	3	L001019	VC 2000 W	200 V; 50/60 Hz	1.7	0.9	28.0	2.9	3	L000779
VC 1200	200 V; 50/60 Hz	1.1	4.8	37.0	2.3	3	L001017	VC 2000 W	200 V; 50/60 Hz	1.0	0.9	28.0	2.3	3	L000778
VC 1200	208-220 V; 60 Hz	1.3	0.9	28.0	2.4	3	L000751	VC 2000 W	200 V; 50/60 Hz	1.7	3.2	37.0	2.9	3	L001037
VC 1200	208-220 V; 60 Hz	2.1	0.9	28.0	3.1	3	L000752	VC 2000 W	200 V; 50/60 Hz	1.1	3.2	37.0	2.3	3	L001035
VC 1200	208-220 V; 60 Hz	1.3	3.2	37.0	2.4	3	L000986	VC 2000 W	200 V; 50/60 Hz	1.7	4.8	37.0	2.9	3	L001038
VC 1200	208-220 V; 60 Hz	2.1	3.2	37.0	3.1	3	L000988	VC 2000 W	200 V; 50/60 Hz	1.1	4.8	37.0	2.3	3	L001036
VC 1200	208-220 V; 60 Hz	1.3	4.8	37.0	2.4	3	L000987	VC 2000 W	208-220 V; 60 Hz	1.3	0.9	28.0	2.5	3	L000761
VC 1200	208-220 V; 60 Hz	2.1	4.8	37.0	3.1	3	L000989	VC 2000 W	208-220 V; 60 Hz	2.1	0.9	28.0	3.2	3	L000762
VC 1200 W	200 V; 50/60 Hz	1.0	0.9	28.0	2.3	3	L000776	VC 2000 W	208-220 V; 60 Hz	2.1	3.2	37.0	3.2	3	L001008
VC 1200 W	200 V; 50/60 Hz	1.7	0.9	28.0	2.9	3	L000777	VC 2000 W	208-220 V; 60 Hz	1.3	3.2	37.0	2.5	3	L001006
VC 1200 W	200 V; 50/60 Hz	1.1	3.2	37.0	2.3	3	L001031	VC 2000 W	208-220 V; 60 Hz	2.1	4.8	37.0	3.2	3	L001007
VC 1200 W	200 V; 50/60 Hz	1.7	3.2	37.0	2.9	3	L001033	VC 2000 W	208-220 V; 60 Hz	1.3	4.8	37.0	2.5	3	L001005
VC 1200 W	200 V; 50/60 Hz	1.1	4.8	37.0	2.3	3	L001032	VC 3000	200 V; 50/60 Hz	1.0	3.2	37.0	2.6	3	L000772
VC 1200 W	200 V; 50/60 Hz	1.7	4.8	37.0	2.9	3	L001034	VC 3000	200 V; 50/60 Hz	1.1	4.8	37.0	2.6	3	L001024
VC 1200 W	208-220 V; 60 Hz	2.1	0.9	28.0	3.1	3	L000760	VC 3000	208-220 V; 60 Hz	1.3	3.2	37.0	2.8	3	L000755
VC 1200 W	208-220 V; 60 Hz	1.3	0.9	28.0	2.4	3	L000759	VC 3000	208-220 V; 60 Hz	1.3	4.8	37.0	2.8	3	L000994
VC 1200 W	208-220 V; 60 Hz	2.1	3.2	37.0	3.1	3	L001003	VC 3000 W	200 V; 50/60 Hz	1.0	3.2	37.0	2.6	3	L000780
VC 1200 W	208-220 V; 60 Hz	1.3	3.2	37.0	2.4	3	L001001	VC 3000 W	200 V; 50/60 Hz	1.1	4.8	37.0	2.6	3	L001039
VC 1200 W	208-220 V; 60 Hz	2.1	4.8	37.0	3.1	3	L001004	VC 3000 W	208-220 V; 60 Hz	1.3	3.2	37.0	2.8	3	L000763
VC 1200 W	208-220 V; 60 Hz	1.3	4.8	37.0	2.4	3	L001002	VC 3000 W	208-220 V; 60 Hz	1.3	4.8	37.0	2.8	3	L001009
VC 2000	200 V; 50/60 Hz	1.7	0.9	28.0	2.9	3	L000771	VC 5000	200 V; 3/PE; 50/60 Hz	3.4	3.2	37.0	4.3	34	L000773
VC 2000	200 V; 50/60 Hz	1.0	0.9	28.0	2.3	3	L000770	VC 5000	200 V; 3/PE; 50/60 Hz	3.4	4.8	37.0	4.3	34	L001025
VC 2000	200 V; 50/60 Hz	1.7	3.2	37.0	2.9	3	L001022	VC 5000	200 V; 3/PE; 50/60 Hz	3.4	4.3	60.0	4.3	34	L001026
VC 2000	200 V; 50/60 Hz	1.1	3.2	37.0	2.3	3	L001020	VC 5000	208-220 V; 3/PE; 60 Hz	4.1	3.2	37.0	4.5	34	L000756
VC 2000	200 V; 50/60 Hz	1.7	4.8	37.0	2.9	3	L001023	VC 5000	208-220 V; 3/PE; 60 Hz	4.1	4.8	37.0	4.5	34	L000995
VC 2000	200 V; 50/60 Hz	1.1	4.8	37.0	2.3	3	L001021	VC 5000	208-220 V; 3/PE; 60 Hz	4.1	5.0	60.0	4.5	34	L000996
VC 2000	208-220 V; 60 Hz	1.3	0.9	28.0	2.5	3	L000753	VC 5000 W	200 V; 3/PE; 50/60 Hz	3.4	3.2	37.0	4.3	34	L000781
VC 2000	208-220 V; 60 Hz	2.1	0.9	28.0	3.2	3	L000754	VC 5000 W	200 V; 3/PE; 50/60 Hz	3.4	4.8	37.0	4.3	34	L001040

*All data for the plug codes can be found on page 150

Device type	Power supply V; Hz	Heater power max. kW	Pump pressure max. bar	Pump flow max. pressure L /min	Loading max. kW	Plug code*	Cat. No.
-------------	--------------------	----------------------	------------------------	--------------------------------	-----------------	------------	----------

Device type	Power supply V; Hz	Heater power max. kW	Pump pressure max. bar	Pump flow max. pressure L /min	Loading max. kW	Plug code*	Cat. No.
-------------	--------------------	----------------------	------------------------	--------------------------------	-----------------	------------	----------

LAUDA Variocool / Page 88

VC 5000 W	200 V; 3/PE; 50/60 Hz	3.4	4.3	60.0	4.3	34	L001041	VC 7000 W	208-220 V; 3/PE; 60 Hz	4.1	4.8	37.0	5.7	33	L001012
VC 5000 W	208-220 V; 3/PE; 60 Hz	4.1	3.2	37.0	4.5	34	L000764	VC 7000 W	208-220 V; 3/PE; 60 Hz	4.1	5.0	60.0	5.7	33	L001013
VC 5000 W	208-220 V; 3/PE; 60 Hz	4.1	4.8	37.0	4.5	34	L001010	VC 10000	200 V; 3/PE; 50/60 Hz	5.7	3.2	37.0	7.6	33	L000775
VC 5000 W	208-220 V; 3/PE; 60 Hz	4.1	5.0	60.0	4.5	34	L001011	VC 10000	200 V; 3/PE; 50/60 Hz	5.7	4.8	37.0	7.6	33	L001029
VC 7000	200 V; 3/PE; 50/60 Hz	3.4	3.2	37.0	5.4	33	L000774	VC 10000	200 V; 3/PE; 50/60 Hz	5.7	4.3	60.0	7.6	33	L001030
VC 7000	200 V; 3/PE; 50/60 Hz	3.4	4.8	37.0	5.4	33	L001027	VC 10000	208-220 V; 3/PE; 60 Hz	6.9	3.2	37.0	7.7	33	L000758
VC 7000	200 V; 3/PE; 50/60 Hz	3.4	4.3	60.0	5.4	33	L001028	VC 10000	208-220 V; 3/PE; 60 Hz	6.9	4.8	37.0	7.7	33	L000999
VC 7000	208-220 V; 3/PE; 60 Hz	4.1	3.2	37.0	5.7	33	L000757	VC 10000	208-220 V; 3/PE; 60 Hz	6.9	5.0	60.0	7.7	33	L001000
VC 7000	208-220 V; 3/PE; 60 Hz	4.1	4.8	37.0	5.7	33	L000997	VC 10000 W	200 V; 3/PE; 50/60 Hz	5.7	3.2	37.0	7.6	33	L000783
VC 7000	208-220 V; 3/PE; 60 Hz	4.1	5.0	60.0	5.7	33	L000998	VC 10000 W	200 V; 3/PE; 50/60 Hz	5.7	4.8	37.0	7.6	33	L001044
VC 7000 W	200 V; 3/PE; 50/60 Hz	3.4	3.2	37.0	5.4	33	L000782	VC 10000 W	200 V; 3/PE; 50/60 Hz	5.7	4.3	60.0	7.6	33	L001045
VC 7000 W	200 V; 3/PE; 50/60 Hz	3.4	4.8	37.0	5.4	33	L001042	VC 10000 W	208-220 V; 3/PE; 60 Hz	6.9	3.2	37.0	7.7	33	L000766
VC 7000 W	200 V; 3/PE; 50/60 Hz	3.4	4.3	60.0	5.4	33	L001043	VC 10000 W	208-220 V; 3/PE; 60 Hz	6.9	4.8	37.0	7.7	33	L001014
VC 7000 W	208-220 V; 3/PE; 60 Hz	4.1	3.2	37.0	5.7	33	L000765	VC 10000 W	208-220 V; 3/PE; 60 Hz	6.9	5.0	60.0	7.7	33	L001015

LAUDA Circulation and process thermostats

More characteristics

LAUDA PRO / Page 82

COOLING POWER Heat transfer liquid: Ethanol

Effective cooling power kW

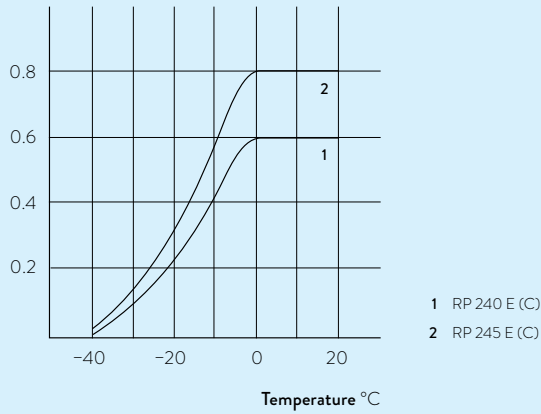

LAUDA Integral XT / Page 86

COOLING POWER Heat transfer liquid: Ultra 350

Effective cooling power kW

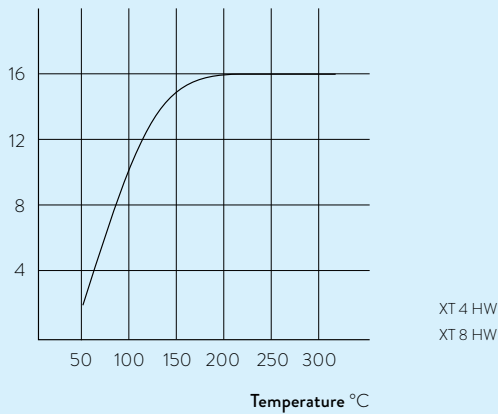

LAUDA-Noah Semistat / Page 92

PUMP CHARACTERISTIC Water

Pressure bar

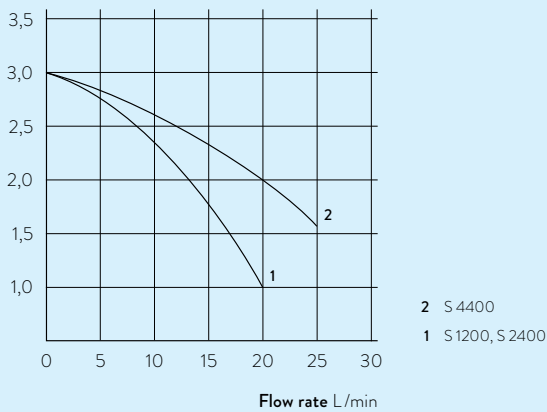

LAUDA CIRCULATION CHILLERS

Specific application examples

- Rotary evaporators
- Distillation systems
- Spectrometers
- Supply of cooling traps
- Digital printing
- Laser cutting
- Laser sorting
- Point welding
- Injection molding
- Tunnel drilling machines
- Centralized cooling water supply



LAUDA Microcool

Circulation chillers for reliable continuous operation in laboratory and research applications from -10 to 40°C

-10°C  40°C

Compact circulation chillers with outstanding price-performance ratio

The LAUDA Microcool line of user-friendly circulation chillers consists of four compact models with large LED display and membrane keypad, offering cooling capacities of 0.25 to 1.2 kW. The highlight of these devices is the premium quality centrifugal pump with magnetic coupling – unique to this price category: Magnetic coupling of pump and electric motor prevents any kind of seal issue from arising on the pump shaft, eliminating the chance for any fluid to leak.



Illuminated viewing glass enables quick identification of the fill level



Standard-issue RS 232 interface and alarm contact

PUMP CHARACTERISTICS Water

Pressure bar

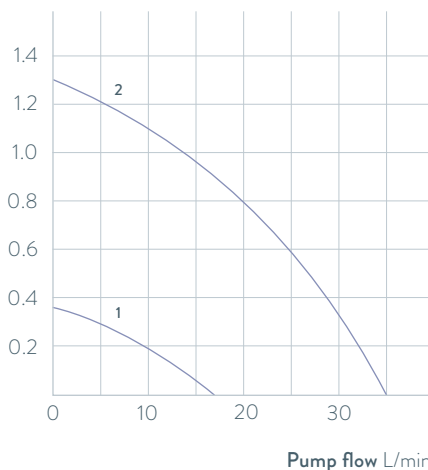

1 MC 250
MC 350
2 MC 600
MC 1200

Important functions

- Auto-start timer and auto shutdown function
- Filling opening at the top, drain connection at the rear
- Cooling capacity adapted via solenoid valve control, including automatic compressor control

Included accessories

Nipples, screw caps

Further accessories

Tubing

All technical data and power supply variants can be found in the ›Technical data‹ section.

More at www.lauda.de/1764



LAUDA Microcool

The compact circulation chillers MC 250 and MC 350 fit effortlessly on a lab bench. Somewhat larger models are also available having 600 and 1200 watts of cooling capacity and which can be positioned on the floor under a lab bench to save space.



LAUDA Variocool

Circulation chillers up to 10 kW from -20 to 40°C for the dissipation of process heat in laboratories, mini plants and production

-20°C  40°C

Comprehensive spectrum of services for demanding temperature control tasks

The LAUDA Variocool circulation chillers impress with their space-saving construction and versatility provided by a wide variety of options. They are simple and convenient to operate via the color TFT display. Other interfaces can be retrofitted to supplement the standard USB interface and alarm contact. Positioned in the front of the device they allow easy access. The working pressure and flow rate can be adapted to the respective requirements in different applications using an integrated bypass and optional pumps to achieve optimum temperature control.



Color TFT display and membrane keypad offer simple and easy adjustment options



Standard-issue USB interface and alarm contact as well as additional optional interfaces that can be retrofitted

PUMP CHARACTERISTIC Water

Pressure bar

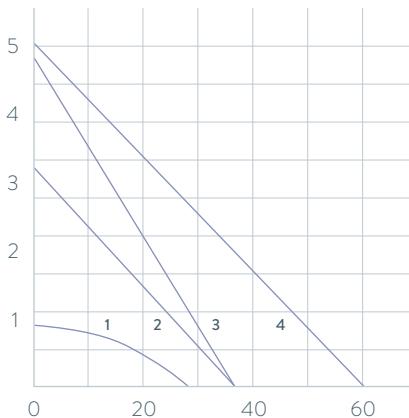

- 1 0,9 bar, 28 L/min
- 2 3,2 bar, 37 L/min
- 3 4,8 bar, 37 L/min
- 4 5,0 bar, 60 L/min

Pump flow L/min

Important functions

- Adjustable bypass for pressure limitation
- Filling opening at the top, drain tap at the rear
- Integral programmer
- Electronic level indicator and low-level alarm
- SmartCool system for energy-saving digital cooling control including automatic compressor control

Included accessories

Nipples, screw caps

Further accessories

Hoses, 2-port and 4-port manifold, ball valves, flow monitors and interface modules

All technical data and power supply variants can be found in the »Technical data« section.

More at www.lauda.de/1766



LAUDA Variocool

All models are available in air and water-cooled versions (W) and fitted with moveable as well as fixable castors. High-performance circulation chillers in a tower design starting from the VC 5000 model are available with sound insulation or the option of outdoor installation.



LAUDA Ultracool

Energy-efficient process circulation chillers from -10 to 35 °C

-10 °C  35 °C

LAUDA Ultracool circulation chillers with an energy saving of up to 50 percent

Developed with a focus on energy efficiency, the new LAUDA Ultracool circulation chillers make a pivotal contribution to reducing your operating costs. Depending on the operating conditions, the new devices make it possible to reduce energy costs by up to 50 percent, with payback times of less than one year. With the innovative operating concept, the LAUDA Ultracool circulation chillers can be conveniently monitored and controlled from a distance - via a connected remote control or the integrated web server. This allows convenient operation via PC or laptop.



Suitable for outdoor installation (IP 54)



Integrated motor fan speed regulator allows operation in ambient conditions up to -15 °C and reduces the noise level

PUMP CHARACTERISTIC Standard pumps (3 bar), 50 Hz

Pressure bar

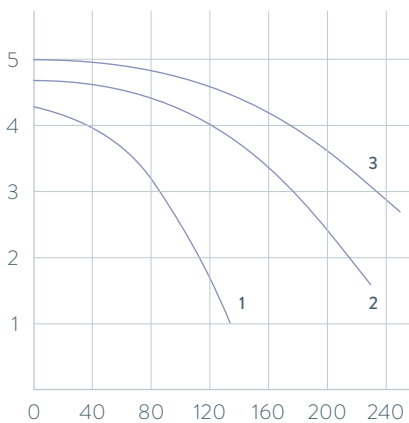

- 3 UC 65
- 2 UC 50
- 1 UC 8, UC 14, UC 24

Important functions

- High energy efficiency results in low operating costs
- Operation via LCD remote control unit or web server
- Increased temperature stability of ± 0.5 K

Included accessories

Ethernet interface, remote control unit, stainless steel connections

Further accessories

Hose kits, reverse flow protection

All technical data and power supply variants can be found in the ›Technical data‹ section.

More at www.lauda.de/de/1778



LAUDA Ultracool

The energy-efficient LAUDA Ultracool circulation chillers comply with the Ecodesign Directive 2009/125/EC. This defines the limit values for energy efficiency (SEPR indices) which process circulation chillers in this performance class must fulfill. Depending on the operating conditions, the new circulation chillers are up to 50 percent more energy-efficient than conventional models.



LAUDA Ultracool

Process circulation chillers with cooling capacities of up to 265 kW from -5 to 25 °C for industrial applications

-5 °C  25 °C

Reliable temperature control and secure operation

Suitable for outdoor installation, the compact LAUDA Ultracool circulation chillers with high cooling capacities are ›Plug & Operate‹ systems with a cold water tank, centrifugal pump and internal bypass. The standard-issue antifreeze protection thermostat prevents freezing of the heat exchanger. Integrated pressure switches also protect the circuit against pressure that is too high or too low and chiller casing made of galvanized steel panels coated with epoxy resin protects against corrosion even in aggressive production environments.



Standard-issue castors for easy positioning at UC Mini



High-quality block pump for low-noise operation

PUMP CHARACTERISTIC Standard pumps (3 bar), 50 Hz

Pressure bar

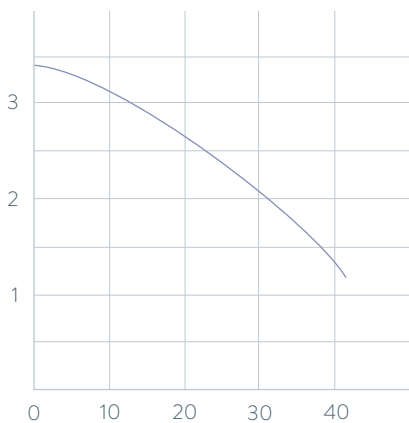

UC 2
UC 4

Pump flow L/min

Important functions

- Premium quality centrifugal pumps
- Water circuit consisting of flexible industrial hoses
- Release valve for draining the circuit

Included accessories

Internal bypass, antifreeze protection thermostat

Further accessories

Tube kits, return valve

All technical data and power supply variants can be found in the ›Technical data‹ section.

More at www.lauda.de/1768



LAUDA Ultracool

The UC Mini circulation chillers UC2 and UC4 have a cooling capacity up to 4.9 kW. In addition to being more compact, the geometry of the devices guarantees easy access to components requiring regular maintenance. The five Ultracool Maxi circulation chillers UC-0800 to UC-2400 have cooling capacities up to 265 kW and are suitable for outdoor installation.



LAUDA Circulation chillers

Device type overview

LAUDA Microcool / Page 114

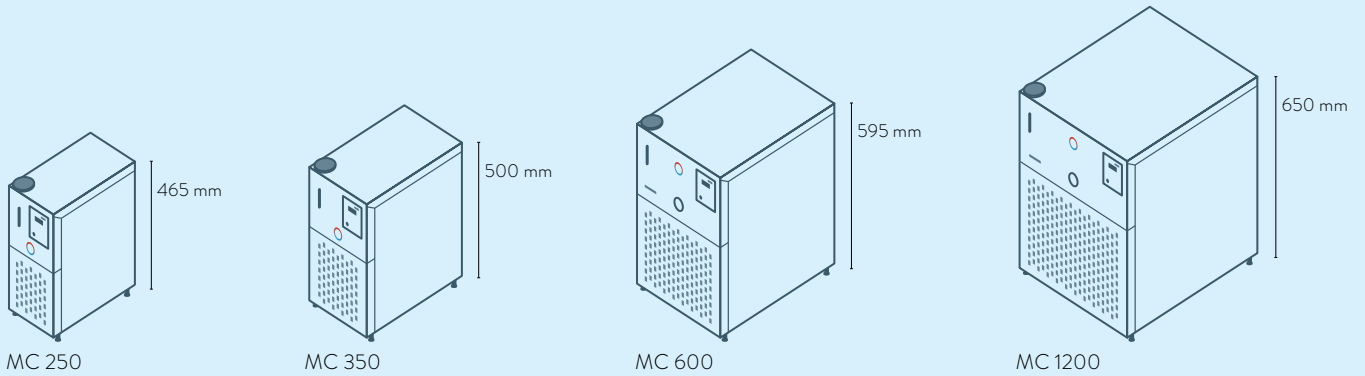

LAUDA Variocool / Page 116

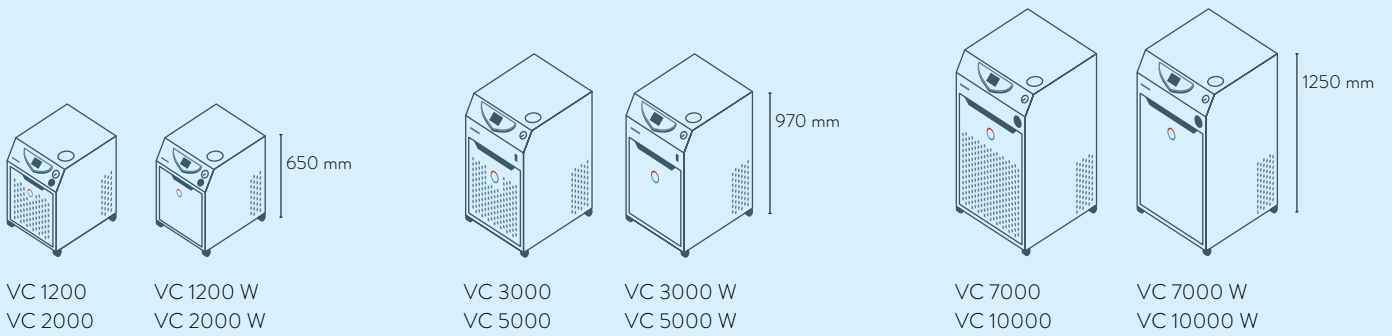

LAUDA Ultracool / Page 118

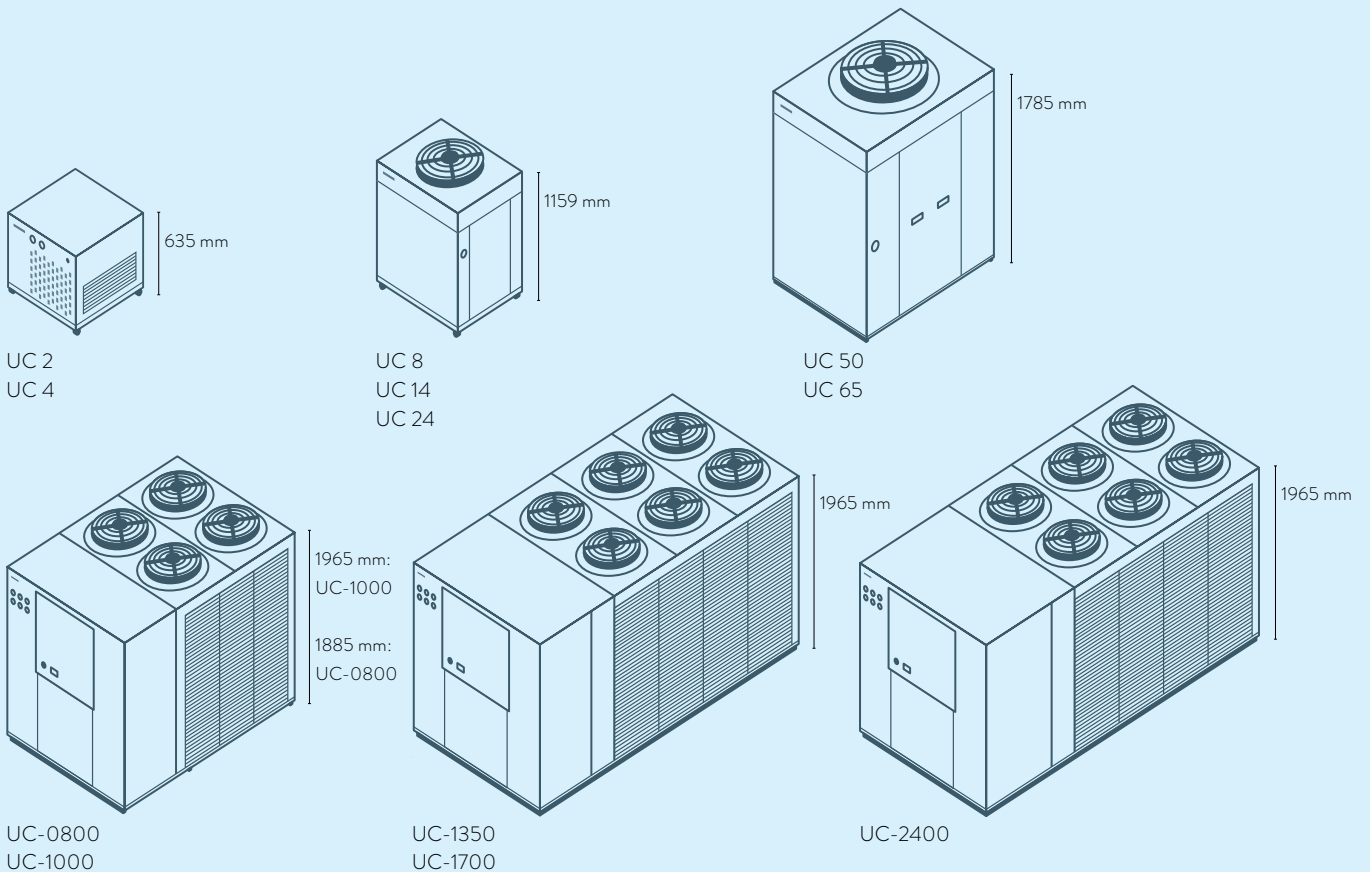

LAUDA Circulation chillers

Interfaces

	Pt 100 (1)	Pt 100 (2)	USB	Ethernet	RS 232 / 485	Analog	Namur contact	Sub-D contact	Profibus	EtherCat M8	EtherCat RJ 45	Modbus	Malfunction contact	Number of module slots, large	Number of module slots, small
LAUDA Microcool / Page 114	-	-	-	-	RS 232	-	-	-	-	-	-	-	S	-	-
LAUDA Variocool / Page 116	Z	-	S	Z	Z	Z	Z	Z	Z	Z	Z	-	S	1	1
LAUDA Ultracool UC 8 - UC 65 / Page 118	-	-	-	S*	-	-	-	-	-	-	-	-	-	-	-
LAUDA Ultracool Mini - Maxi / Page 120	-	-	-	-	-	-	-	-	-	-	-	OD	-	-	-

S = Series standard

S* = Ethernet with Modbus TCP/IP protocol

Z = Available as an accessory

OD = optional (cannot be retrofitted)



LRZ 912
Analog module



LRZ 913
RS 232/485
interface

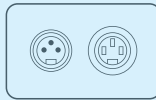

LRZ 914
Contact module with single input
and single output (NAMUR)



LRZ 915
Contact module with
3 inputs and 3 outputs



LRZ 917
Profibus module

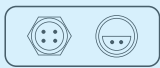

LRZ 918
Pt100/Li bus module,
small cover



LRZ 921
Ethernet module

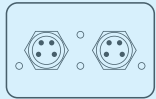

LRZ 922
EtherCAT module
with M8 connection

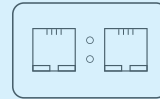

LRZ 923
EtherCAT module
with RJ45 connection

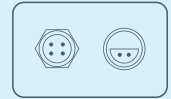

LRZ 925
External Pt100/LiBus-
module, large cover

LAUDA Circulation chillers

Function overview

Operating element	Microcool	Variocool	Ultracool UC 8 - UC 65	Ultracool Mini, Maxi
Display	7-Segment	TFT	LCD	LCD mono
Mode of operation	3-button	Cursor softkey	6-button	3-button softkey
1-point calibration	√	√	-	-
Programmer, programs/segments	-	5 / 150	-	-
Programmer, tolerance range function	-	√	-	-
Graphic temperature profile display	-	√	-	-
Pump pressure display (analog)	- / √	√	√	√
Pump pressure display (digital)	-	-	√	-
Adjustable bypass	-	√	√	√
Level indicator (analog)	√	-	-	-
Level indicator (digital)	-	√	-	-
Standby timer	√	√	-	√
Flow control instrument	-	Z	-	-
Overflow	√	-	-	-
Low-level alarm	√	√	√	√
Drain tap	-	√	√	√
Drain screw	√	-	-	-

LAUDA Circulation chillers

Technical data according to DIN 12876 standard

Device type	Working temperature range °C	Temperature stability* ±K	Ambient temperature range °C	Cooling of the refrigerating machine	Heater power max. kW	Cooling output kW					Pump pressure max. bar	Pump flow max. pressure L/min	Pump connection thread mm	Bath volume min. L
						20 °C	10 °C	0 °C	-10 °C	-20 °C				
LAUDA Microcool / Page 114														
MC 250	-10 ... 40	0.50	5 ... 40	Air	-	0.25	0.20	0.15	0.09	-	0.4	16	Ø 10 mm	2.0
MC 350	-10 ... 40	0.50	5 ... 40	Air	-	0.35	0.27	0.20	0.12	-	0.4	16	Ø 10 mm	4.0
MC 600	-10 ... 40	0.50	5 ... 40	Air	-	0.60	0.50	0.36	0.15	-	1.3	35	G 3/4	4.0
MC 1200	-10 ... 40	0.50	5 ... 40	Air	-	1.20	1.05	0.75	0.40	-	1.3	35	G 3/4	7.0
LAUDA Variocool / Page 116														
VC 1200	-20 ... 40	0.05	5 ... 40	Air	-	1.20	1.00	0.70	0.40	0.14	0.9	28	G 3/4	8.0
VC 1200	-20 ... 40	0.05	5 ... 40	Air	-	1.12	0.92	0.62	0.32	0.06	3.2	37	G 3/4	8.0
VC 1200	-20 ... 40	0.05	5 ... 40	Air	-	1.00	0.80	0.50	0.20	0.01	4.8	37	G 3/4	8.0
VC 1200 W	-20 ... 40	0.05	5 ... 40	Water	-	1.20	1.00	0.70	0.40	0.14	0.9	28	G 3/4	8.0
VC 1200 W	-20 ... 40	0.05	5 ... 40	Water	-	1.12	0.92	0.62	0.32	0.06	3.2	37	G 3/4	8.0
VC 1200 W	-20 ... 40	0.05	5 ... 40	Water	-	1.00	0.80	0.50	0.20	0.01	4.8	37	G 3/4	8.0
VC 2000	-20 ... 40	0.05	5 ... 40	Air	-	2.00	1.50	1.06	0.68	0.38	0.9	28	G 3/4	8.0
VC 2000	-20 ... 40	0.05	5 ... 40	Air	-	1.92	1.42	0.98	0.60	0.30	3.2	37	G 3/4	8.0
VC 2000	-20 ... 40	0.05	5 ... 40	Air	-	1.80	1.30	0.86	0.48	0.18	4.8	37	G 3/4	8.0
VC 2000 W	-20 ... 40	0.05	5 ... 40	Water	-	2.00	1.50	1.06	0.68	0.38	0.9	28	G 3/4	8.0
VC 2000 W	-20 ... 40	0.05	5 ... 40	Water	-	1.92	1.42	0.98	0.60	0.30	3.2	37	G 3/4	8.0
VC 2000 W	-20 ... 40	0.05	5 ... 40	Water	-	1.80	1.30	0.86	0.48	0.18	4.8	37	G 3/4	8.0
VC 3000	-20 ... 40	0.05	5 ... 40	Air	-	3.00	2.40	1.68	0.95	0.45	3.2	37	G 3/4	20.0
VC 3000	-20 ... 40	0.05	5 ... 40	Air	-	2.80	2.20	1.48	0.75	0.25	4.8	37	G 3/4	20.0
VC 3000 W	-20 ... 40	0.05	5 ... 40	Water	-	3.00	2.40	1.68	0.95	0.45	3.2	37	G 3/4	20.0
VC 3000 W	-20 ... 40	0.05	5 ... 40	Water	-	2.80	2.20	1.48	0.75	0.25	4.8	37	G 3/4	20.0
VC 5000	-20 ... 40	0.05	5 ... 40	Air	-	5.00	3.90	2.75	1.70	0.90	3.2	37	G 3/4	20.0
VC 5000	-20 ... 40	0.05	5 ... 40	Air	-	4.50	3.40	2.25	1.20	0.40	4.8	37	G 3/4	20.0
VC 5000	-20 ... 40	0.05	5 ... 40	Air	-	4.65	3.55	2.40	1.35	0.55	5.0	60	G 3/4	20.0
VC 5000 W	-20 ... 40	0.05	5 ... 40	Water	-	5.00	3.90	2.75	1.70	0.90	3.2	37	G 3/4	20.0
VC 5000 W	-20 ... 40	0.05	5 ... 40	Water	-	4.50	3.40	2.25	1.20	0.40	4.8	37	G 3/4	20.0
VC 5000 W	-20 ... 40	0.05	5 ... 40	Water	-	4.65	3.55	2.40	1.35	0.55	5.0	60	G 3/4	20.0
VC 7000	-20 ... 40	0.10	5 ... 40	Air	-	7.00	5.30	3.70	2.40	1.30	3.2	37	G 1 1/4	48.0
VC 7000	-20 ... 40	0.10	5 ... 40	Air	-	6.50	4.80	3.20	1.90	0.80	4.8	37	G 1 1/4	48.0
VC 7000	-20 ... 40	0.10	5 ... 40	Air	-	6.65	4.95	3.35	2.05	0.95	5.0	60	G 1 1/4	48.0

*For Variocool: load-dependent

Bath volume max. L	Dimensions (W x D x H) mm	Protection Rating	Noise level dB (A)	Weight kg	Loading max. kW	Power supply V; Hz	Cat. No.	Device type
4.0	200 x 350 x 465	IP 32	60	26.0	0.2	230 V; 50 Hz	L001046	MC 250
7.0	240 x 400 x 500	IP 32	60	35.0	0.5	230 V; 50 Hz	L001047	MC 350
8.0	350 x 480 x 595	IP 32	57	51.0	0.7	230 V; 50 Hz	L001048	MC 600
14.0	450 x 550 x 650	IP 32	59	64.0	1.2	230 V; 50 Hz	L001049	MC 1200
15.0	450 x 550 x 650	IP 32	51	54.0	1.1	230 V; 50 Hz	L000657	VC 1200
15.0	450 x 550 x 790	IP 32	53	54.0	1.1	230 V; 50 Hz	L000784	VC 1200
15.0	450 x 550 x 790	IP 32	57	54.0	1.1	230 V; 50 Hz	L000785	VC 1200
15.0	450 x 550 x 650	IP 32	50	51.0	1.1	230 V; 50 Hz	L000671	VC 1200 W
15.0	450 x 550 x 790	IP 32	52	51.0	1.1	230 V; 50 Hz	L000805	VC 1200 W
15.0	450 x 550 x 790	IP 32	56	51.0	1.1	230 V; 50 Hz	L000806	VC 1200 W
15.0	450 x 550 x 650	IP 32	52	57,0	1.6	230 V; 50 Hz	L000658	VC 2000
15.0	450 x 550 x 790	IP 32	56	57.0	1.6	230 V; 50 Hz	L000786	VC 2000
15.0	450 x 550 x 790	IP 32	58	57.0	1.6	230 V; 50 Hz	L000787	VC 2000
15.0	450 x 550 x 650	IP 32	50	54.0	1.6	230 V; 50 Hz	L000672	VC 2000 W
15.0	450 x 550 x 790	IP 32	53	54.0	1.6	230 V; 50 Hz	L000807	VC 2000 W
15.0	450 x 550 x 790	IP 32	56	54.0	1.6	230 V; 50 Hz	L000808	VC 2000 W
33.0	550 x 650 x 970	IP 32	57	93.0	1.8	230 V; 50 Hz	L000659	VC 3000
33.0	550 x 650 x 970	IP 32	61	93.0	1.8	230 V; 50 Hz	L000788	VC 3000
33.0	550 x 650 x 970	IP 32	55	89.0	1.8	230 V; 50 Hz	L000673	VC 3000 W
33.0	550 x 650 x 970	IP 32	59	89.0	1.8	230 V; 50 Hz	L000809	VC 3000 W
33.0	550 x 650 x 970	IP 32	65	98.0	3.3	400 V; 3/N/PE; 50 Hz	L000668	VC 5000
33.0	550 x 650 x 970	IP 32	69	98.0	3.3	400 V; 3/N/PE; 50 Hz	L000799	VC 5000
33.0	550 x 650 x 970	IP 32	69	98.0	3.3	400 V; 3/N/PE; 50 Hz	L000802	VC 5000
33.0	550 x 650 x 970	IP 32	64	94.0	3.3	400 V; 3/N/PE; 50 Hz	L000680	VC 5000 W
33.0	550 x 650 x 970	IP 32	68	94.0	3.3	400 V; 3/N/PE; 50 Hz	L000820	VC 5000 W
33.0	550 x 650 x 970	IP 32	68	94.0	3.3	400 V; 3/N/PE; 50 Hz	L000823	VC 5000 W
64.0	650 x 670 x 1250	IP 32	66	138.0	4.3	400 V; 3/N/PE; 50 Hz	L000669	VC 7000
64.0	650 x 670 x 1250	IP 32	69	138.0	4.3	400 V; 3/N/PE; 50 Hz	L000800	VC 7000
64.0	650 x 670 x 1250	IP 32	69	138.0	4.3	400 V; 3/N/PE; 50 Hz	L000803	VC 7000

LAUDA Circulation chillers

Technical data according to DIN 12876 standard

Device type	Working temperature range °C	Temperature stability* ±K	Ambient temperature range °C	Cooling of the refrigerating machine	Heater power max. kW	Cooling output kW					Pump pressure max. bar	Pump flow max. pressure L/min	Pump connection thread mm	Bath volume min. L
						20 °C	10 °C	0 °C	-10 °C	-20 °C				
LAUDA Variocool / Page 116														
VC 7000 W	-20 ... 40	0.10	5 ... 40	Water	-	7.00	5.30	3.70	2.40	1.30	3.2	37	G 1 1/4	48.0
VC 7000 W	-20 ... 40	0.10	5 ... 40	Water	-	6.50	4.80	3.20	1.90	0.80	4.8	37	G 1 1/4	48.0
VC 7000 W	-20 ... 40	0.10	5 ... 40	Water	-	6.65	4.95	3.35	2.05	0.95	5.0	60	G 1 1/4	48.0
VC 10000	-20 ... 40	0.10	5 ... 40	Air	-	10.00	7.60	5.30	3.50	2.00	3.2	37	G 1 1/4	48.0
VC 10000	-20 ... 40	0.10	5 ... 40	Air	-	9.50	7.10	4.80	3.00	1.50	4.8	37	G 1 1/4	48.0
VC 10000	-20 ... 40	0.10	5 ... 40	Air	-	9.65	7.25	4.95	3.15	1.65	5.0	60	G 1 1/4	48.0
VC 10000 W	-20 ... 40	0.10	5 ... 40	Water	-	10.00	7.60	5.30	3.50	2.00	3.2	37	G 1 1/4	48.0
VC 10000 W	-20 ... 40	0.10	5 ... 40	Water	-	9.50	7.10	4.80	3.00	1.50	4.8	37	G 1 1/4	48.0
VC 10000 W	-20 ... 40	0.10	5 ... 40	Water	-	9.65	7.25	4.95	3.15	1.65	5.0	60	G 1 1/4	48.0

*load-dependent

Bath volume max. L	Dimensions (W x D x H) mm	Protection Rating	Noise level dB (A)	Weight kg	Loading max. kW	Power supply V; Hz	Cat. No.	Device type
64.0	650×670×1250	IP 32	60	131.0	4.3	400 V; 3/N/PE; 50 Hz	L000681	VC 7000 W
64.0	650×670×1250	IP 32	64	131.0	4.3	400 V; 3/N/PE; 50 Hz	L000821	VC 7000 W
64.0	650×670×1250	IP 32	64	131.0	4.3	400 V; 3/N/PE; 50 Hz	L000824	VC 7000 W
64.0	650×670×1250	IP 32	67	147.0	5.4	400 V; 3/N/PE; 50 Hz	L000670	VC 10000
64.0	650×670×1250	IP 32	70	147.0	5.4	400 V; 3/N/PE; 50 Hz	L000801	VC 10000
64.0	650×670×1250	IP 32	70	147.0	5.4	400 V; 3/N/PE; 50 Hz	L000804	VC 10000
64.0	650×670×1250	IP 32	61	140.0	5.4	400 V; 3/N/PE; 50 Hz	L000682	VC 10000 W
64.0	650×670×1250	IP 32	65	140.0	5.4	400 V; 3/N/PE; 50 Hz	L000822	VC 10000 W
64.0	650×670×1250	IP 32	65	140.0	5.4	400 V; 3/N/PE; 50 Hz	L000825	VC 10000 W

LAUDA Circulation chillers

Technical data

Device type	Working temperature range °C	Temperature stability ±K	Ambient temperature range °C	Cooling output at water outlet temperature ¹ kW								Number of refrigerant circuits	Motor fan			Pump pressure max. bar
				35 - 25 °C	20 °C	15 °C	10 °C	5 °C	0 °C	-5 °C	-10 °C		No.	kW	m ³ /h	
LAUDA Ultracool / Page 118																
UC 2	-5...25	2	-15...50	2.80	2.80	2.50	2.10	1.80	1.50	1.20	-	1	1	0.18	2400	3.4
UC 4	-5...25	2	-15...50	6.90	6.90	5.90	4.90	4.10	3.40	2.80	-	1	1	0.18	2400	3.4
UC 8	-10...35	0.5	-15...50	13.3	13.3	12.0	10.2	8.5	7.0	5.4	4.4	1	1	0.5	4500	4.2
UC 14	-10...35	0.5	-15...50	22.4	20.3	18.4	15.8	13.4	11.1	9.3	7.6	1	1	1.0	7500	4.2
UC 24	-10...35	0.5	-15...50	34.0	30.9	28.1	24.3	20.8	17.3	14.5	12.0	1	1	1.0	7500	4.2
UC 50	-10...35	0.5	-15...50	67.5	65.6	59.4	51.2	43.7	36.4	30.4	25.2	1	1	2.6	19000	4.6
UC 65	-10...35	0.5	-15...50	87.5	85.2	77.4	66.9	57.3	47.8	40.1	33.3	1	1	2.6	19000	5
UC-0800	-5...25	2	-15...45	114.30	114.30	103.00	87.90	72.30	57.80	45.40	-	2	4	2.40	36000	4.7
UC-1000	-5...25	2	-15...45	140.80	140.80	126.10	106.40	85.90	67.00	51.20	-	2	4	2.40	40800	3.7
UC-1350	-5...25	2	-15...45	182.10	182.10	163.70	139.20	113.70	90.00	69.80	-	2	6	3.60	57000	5.5
UC-1700	-5...25	2	-15...45	228.40	228.40	205.90	175.70	144.60	115.60	90.80	-	2	6	3.60	55200	5.2
UC-2400	-5...25	2	-15...45	336.90	336.90	308.80	265.00	223.10	182.80	148.20	-	2	6	7.50	66000	5.2

¹ at 25 °C ambient temperature

² Rp = G = BSP (internal screw thread acc. to British Standard Pipe)

Correction factor ambient temperature; $C_{NOM} = C_{WORK} \times F$

Ambient temperature	25	30	35	40	45
Correction factor F	1	0.9	0.85	0.78	0.66

Note: The values calculated with the correction factors are only approximated values

Pump flow max. L/min	Pump pressure nominal bar	Pump flow nominal L/min	Pump connection thread ² mm	Volume water tank L	Dimensions (W × D × H) mm	Protection Rating	Noise level ¹ dB (A)	Weight kg	Loading max. kW	Max. fuse A	Power supply V; Hz	Cat. No.	Device type
42	3.3	5.6	Rp 1/2	19	640×640×635	IP 44	40.0	80	1.4	16	230 V; 50 Hz	E6002411	UC 2
42	2.8	13.8	Rp 1/2	19	640×640×635	IP 44	42.5	85	1.8	16	230 V; 50 Hz	E6004411	UC 4
130	4.0	-	Rp 1	35	720×910×1280	IP 54	61.0	150	3.4	25	400 V; 3/PE; 50 Hz / 460 V; 3/PE; 60 Hz	L002853	UC 8
130	3.7	-	Rp 1	35	720×910×1250	IP 54	64.7	175	5.1	25	400 V; 3/PE; 50 Hz / 460 V; 3/PE; 60 Hz	L002854	UC 14
130	2.7	-	Rp 1	35	720×910×1250	IP 54	64.7	180	8.0	32	400 V; 3/PE; 50 Hz / 460 V; 3/PE; 60 Hz	L002855	UC 24
230	3.3	-	Rp 1 1/2	210	1040×1435×1890	IP 54	68.7	410	14.8	50	400 V; 3/PE; 50 Hz / 460 V; 3/PE; 60 Hz	L002856	UC 50
250	3.3	-	Rp 1 1/2	210	1040×1435×1890	IP 54	69.5	440	20.4	63	400 V; 3/PE; 50 Hz / 460 V; 3/PE; 60 Hz	L002857	UC 65
420	3.4	247.0	Rp 2	300	1545×2230×2010	IP 54	58.3	1020	27.5	80	400 V; 3/PE; 50 Hz	E6080223	UC-0800
500	3.5	299.0	Rp 2 1/2	500	1660×3400×2090	IP 54	63.1	1460	33.4	100	400 V; 3/PE; 50 Hz	E6100221	UC-1000
500	4.5	392.0	Rp 2 1/2	500	1660×3400×2090	IP 54	62.2	1570	43.8	150	400 V; 3/PE; 50 Hz	E6135221	UC-1350
670	3.4	494.0	Rp 2 1/2	500	1660×3400×2090	IP 54	61.3	1630	54.9	150	400 V; 3/PE; 50 Hz	E6170221	UC-1700
970	3.6	733.0	DIN-2566 DN80	500	1660×3585×2090	IP 54	62.7	1690	71.4	200	400 V; 3/PE; 50 Hz	E6240221	UC-2400

LAUDA Circulation chillers

Power supply variants

Device type	Power supply V; Hz	Pump pressure max. bar	Pump flow max. pressure L /min	Loading max. kW	Plug code*	Cat. No.	Device type	Power supply V; Hz	Pump pressure max. bar	Pump flow max. pressure L /min	Loading max. kW	Plug code*	Cat. No.
LAUDA Microcool / Page 114													
MC 250	100 V; 50/60 Hz	0.4	16.0	0.2	14	L001071	MC 600	100 V; 50/60 Hz	1.3	35.0	0.8	14	L001073
MC 250	115 V; 60 Hz	0.4	16.0	0.2	14	L001066	MC 600	115 V; 60 Hz	1.3	35.0	0.8	14	L001068
MC 250	220 V; 60 Hz	0.4	16.0	0.2	6	L002167	MC 1200	100 V; 50/60 Hz	1.3	35.0	1.1	14	L001074
MC 350	100 V; 50/60 Hz	0.4	16.0	0.5	14	L001072	MC 1200	115 V; 60 Hz	1.3	35.0	1.1	14	L001069
MC 350	115 V; 60 Hz	0.4	16.0	0.5	14	L001067	MC 1200	220 V; 60 Hz	1.3	35.0	1.2	6	L002170
MC 350	220 V; 60 Hz	0.4	16.0	0.5	6	L002168							
LAUDA Variocool / Page 116													
VC 1200	200 V; 50/60 Hz	0.9	28.0	1.3	3	L000698	VC 3000	200 V; 50/60 Hz	3.2	37.0	2.2	3	L000700
VC 1200	200 V; 50/60 Hz	3.2	37.0	1.3	3	L000848	VC 3000	200 V; 50/60 Hz	4.8	37.0	2.2	3	L000852
VC 1200	200 V; 50/60 Hz	4.8	37.0	1.3	3	L000849	VC 3000	208-220 V; 60 Hz	3.2	37.0	2.3	3	L000687
VC 1200	208-220 V; 60 Hz	0.9	28.0	1.4	3	L000685	VC 3000	208-220 V; 60 Hz	4.8	37.0	2.3	3	L000830
VC 1200	208-220 V; 60 Hz	3.2	37.0	1.4	3	L000826	VC 3000 W	200 V; 50/60 Hz	3.2	37.0	2.2	3	L000706
VC 1200	208-220 V; 60 Hz	4.8	37.0	1.4	3	L000827	VC 3000 W	200 V; 50/60 Hz	4.8	37.0	2.2	3	L000863
VC 1200 W	200 V; 50/60 Hz	0.9	28.0	1.3	3	L000704	VC 3000 W	208-220 V; 60 Hz	3.2	37.0	2.3	3	L000693
VC 1200 W	200 V; 50/60 Hz	3.2	37.0	1.3	3	L000859	VC 3000 W	208-220 V; 60 Hz	4.8	37.0	2.3	3	L000841
VC 1200 W	200 V; 50/60 Hz	4.8	37.0	1.3	3	L000860	VC 5000	200 V; 3/PE; 50/60 Hz	3.2	37.0	3.5	34	L000701
VC 1200 W	208-220 V; 60 Hz	0.9	28.0	1.4	3	L000691	VC 5000	200 V; 3/PE; 50/60 Hz	4.8	37.0	3.5	34	L000853
VC 1200 W	208-220 V; 60 Hz	3.2	37.0	1.4	3	L000837	VC 5000	200 V; 3/PE; 50/60 Hz	4.3	60.0	3.5	34	L000856
VC 1200 W	208-220 V; 60 Hz	4.8	37.0	1.4	3	L000838	VC 5000	208-220 V; 3/PE; 60 Hz	3.2	37.0	3.6	34	L000688
VC 2000	200 V; 50/60 Hz	0.9	28.0	2.0	3	L000699	VC 5000	208-220 V; 3/PE; 60 Hz	4.8	37.0	3.6	34	L000831
VC 2000	200 V; 50/60 Hz	3.2	37.0	2.0	3	L000850	VC 5000	208-220 V; 3/PE; 60 Hz	5.0	60.0	3.6	34	L000834
VC 2000	200 V; 50/60 Hz	4.8	37.0	2.0	3	L000851	VC 5000 W	200 V; 3/PE; 50/60 Hz	3.2	37.0	3.5	34	L000707
VC 2000	208-220 V; 60 Hz	0.9	28.0	2.2	3	L000686	VC 5000 W	200 V; 3/PE; 50/60 Hz	4.8	37.0	3.5	34	L000864
VC 2000	208-220 V; 60 Hz	3.2	37.0	2.2	3	L000829	VC 5000 W	200 V; 3/PE; 50/60 Hz	4.3	60.0	3.5	34	L000867
VC 2000	208-220 V; 60 Hz	4.8	37.0	2.2	3	L000828	VC 5000 W	208-220 V; 3/PE; 60 Hz	3.2	37.0	3.6	34	L000694
VC 2000 W	200 V; 50/60 Hz	0.9	28.0	2.0	3	L000705	VC 5000 W	208-220 V; 3/PE; 60 Hz	4.8	37.0	3.6	34	L000842
VC 2000 W	200 V; 50/60 Hz	3.2	37.0	2.0	3	L000861	VC 5000 W	208-220 V; 3/PE; 60 Hz	5.0	60.0	3.6	34	L000845
VC 2000 W	200 V; 50/60 Hz	4.8	37.0	2.0	3	L000862	VC 7000	200 V; 3/PE; 50/60 Hz	3.2	37.0	4.5	33	L000702
VC 2000 W	208-220 V; 60 Hz	0.9	28.0	2.2	3	L000692	VC 7000	200 V; 3/PE; 50/60 Hz	4.8	37.0	4.5	33	L000854
VC 2000 W	208-220 V; 60 Hz	3.2	37.0	2.2	3	L000840	VC 7000	200 V; 3/PE; 50/60 Hz	4.3	60.0	4.5	33	L000857
VC 2000 W	208-220 V; 60 Hz	4.8	37.0	2.2	3	L000839	VC 7000	208-220 V; 3/PE; 60 Hz	3.2	37.0	4.6	33	L000689

*All data for the plug codes can be found on page 150

Device type	Power supply V; Hz	Pump pressure max. bar	Pump flow max. pressure L /min	Loading max. kW	Plug code*	Cat. No.	Device type	Power supply V; Hz	Pump pressure max. bar	Pump flow max. pressure L /min	Loading max. kW	Plug code*	Cat. No.
-------------	--------------------	------------------------	--------------------------------	-----------------	------------	----------	-------------	--------------------	------------------------	--------------------------------	-----------------	------------	----------

LAUDA Variocool / Page 116

VC 7000	208-220 V; 3/PE; 60 Hz	4.8	37.0	4.6	33	L000832	VC 10000	200 V; 3/PE; 50/60 Hz	4.3	60.0	5.7	33	L000858
VC 7000	208-220 V; 3/PE; 60 Hz	5.0	60.0	4.6	33	L000835	VC 10000	208-220 V; 3/PE; 60 Hz	3.2	37.0	5.9	33	L000690
VC 7000 W	200 V; 3/PE; 50/60 Hz	3.2	37.0	4.5	33	L000708	VC 10000	208-220 V; 3/PE; 60 Hz	4.8	37.0	5.9	33	L000833
VC 7000 W	200 V; 3/PE; 50/60 Hz	4.8	37.0	4.5	33	L000865	VC 10000	208-220 V; 3/PE; 60 Hz	5.0	60.0	5.9	33	L000836
VC 7000 W	200 V; 3/PE; 50/60 Hz	4.3	60.0	4.5	33	L000868	VC 10000 W	200 V; 3/PE; 50/60 Hz	3.2	37.0	5.7	33	L000709
VC 7000 W	208-220 V; 3/PE; 60 Hz	3.2	37.0	4.6	33	L000695	VC 10000 W	200 V; 3/PE; 50/60 Hz	4.8	37.0	5.7	33	L000866
VC 7000 W	208-220 V; 3/PE; 60 Hz	4.8	37.0	4.6	33	L000843	VC 10000 W	200 V; 3/PE; 50/60 Hz	4.3	60.0	5.7	33	L000869
VC 7000 W	208-220 V; 3/PE; 60 Hz	5.0	60.0	4.6	33	L000846	VC 10000 W	208-220 V; 3/PE; 60 Hz	3.2	37.0	5.9	33	L000696
VC 10000	200 V; 3/PE; 50/60 Hz	3.2	37.0	5.7	33	L000703	VC 10000 W	208-220 V; 3/PE; 60 Hz	4.8	37.0	5.9	33	L000844
VC 10000	200 V; 3/PE; 50/60 Hz	4.8	37.0	5.7	33	L000855	VC 10000 W	208-220 V; 3/PE; 60 Hz	5.0	60.0	5.9	33	L000847

LAUDA Ultracool / Page 118

UC 2	230 V; 60 Hz	3.5	50	1.4	-	E6002431	UC-1350	460 V; 3/PE; 60 Hz	5.4	600	55.3	-	E6135241
UC 4	230 V; 60 Hz	3.5	50	1.8	-	E6004431	UC-1700	460 V; 3/PE; 60 Hz	5.4	600	70.2	-	E6170241
UC-0800	460 V; 3/PE; 60 Hz	4.8	300	35.4	-	E6080241	UC-2400	460 V; 3/PE; 60 Hz	3.7	1170	96.1	-	E6240241
UC-1000	460 V; 3/PE; 60 Hz	5.2	430	42.1	-	E6100241							

LAUDA Circulation chillers

More characteristics

LAUDA Ultracool / Page 118

PUMP CHARACTERISTIC Water

Pressure bar

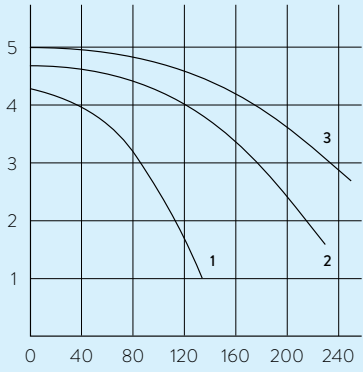

- 3 UC 65
- 2 UC 50
- 1 UC 8, UC 14, UC 24

PUMP CHARACTERISTIC Water

Pressure bar

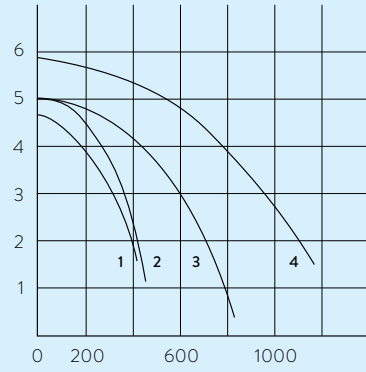

- 1 UC 0800
- 2 UC 1000
- 3 UC 1350
- 4 UC 1700
- 5 UC 2400

LAUDA CALIBRATION THERMOSTATS

Specific application examples

- Calibration of thermometers
- Validation of temperature sensors
- Quality testing heat meter



LAUDA ECO

Calibration and adjustment of temperatures from -25 to 200 °C with LAUDA calibration thermostats



High-performance comprehensive solution for calibration and adjustment

LAUDA calibration thermostats provide constant temperature and homogeneity in calibration and adjustment in the test chamber. Depending on the desired size, bath opening and usable depth, different types are available to choose from – each having variable testing chambers, as well as a comprehensive range of products and accessories. The ability of the thermostat to transfer heat through its heat transfer liquid 40 to 60 times better than through air makes it the perfect solution, especially in comparison to heating cabinets and metal block thermostats.

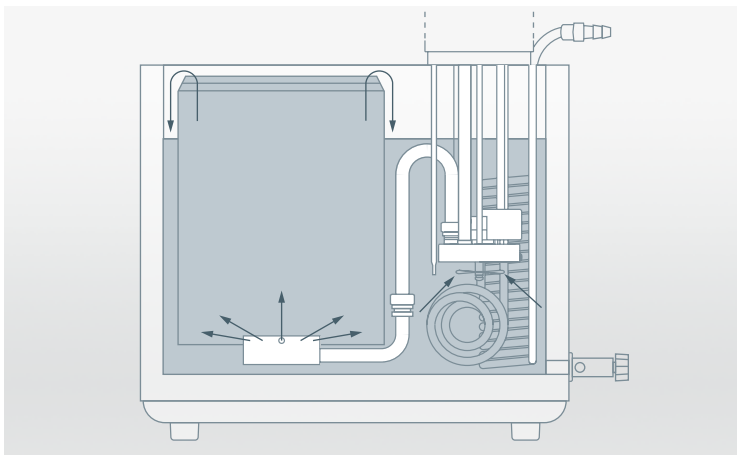

Constant immersion depth thanks to a calibration chamber with overflow principle



Simple operation via TFT display

COOLING PERFORMANCE Heat transfer liquid: Ethanol, bath closed

Bath temperature °C

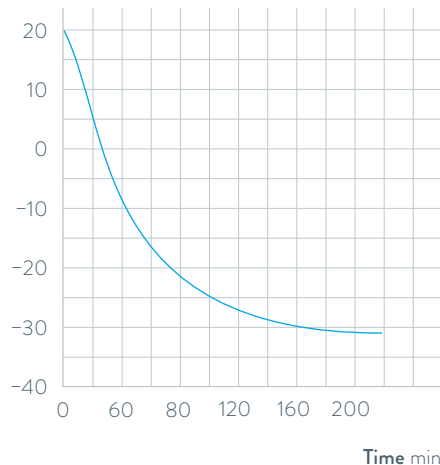

REJ1225 G

Important functions

- LAUDA Vario pump with six selectable output levels
- Vertical adjustment of the temperature chamber possible
- Stainless steel bath vessel (insulated, with handles and drain tap)
- USB interface as standard
- Programmer

Included accessories

Nipples, screw caps, bath cover

Further accessories

Calibration racks

All technical data and power supply variants can be found in the »Technical data« section.

More at www.lauda.de/1772



LAUDA ECO

Temperature stabilities up to $\pm 0.02\text{K}$ at temperatures up to -25°C are achieved with the LAUDA ECO calibration thermostats.



LAUDA Proline

Calibration and adjustment of temperatures from -40 to 300 °C with LAUDA calibration thermostats



High-performance comprehensive solution for calibration and adjustment

LAUDA calibration thermostats provide constant temperature and homogeneity in calibration and adjustment in the test chamber. Depending on the desired size, bath opening and usable depth, different types are available to choose from – each having variable testing chambers, as well as a comprehensive range of products and accessories.

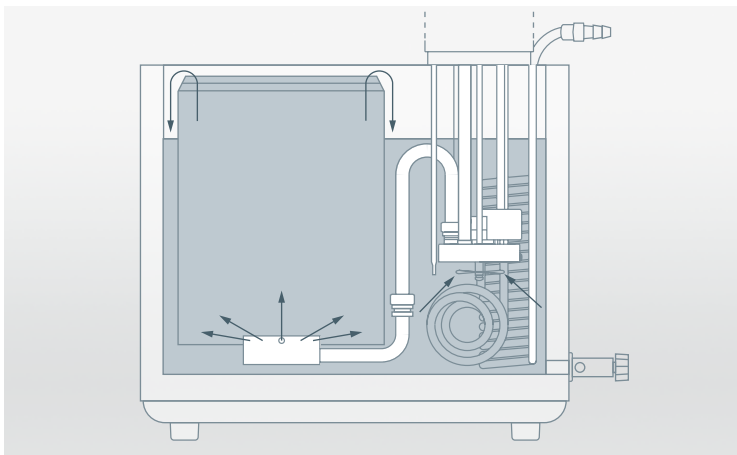

Constant immersion depth thanks to a calibration chamber with overflow principle



Removable remote control "Command" for easy and intuitive operation

HEATING PERFORMANCE Heat transfer liquid: Ultra 240, bath closed

Bath temperature °C

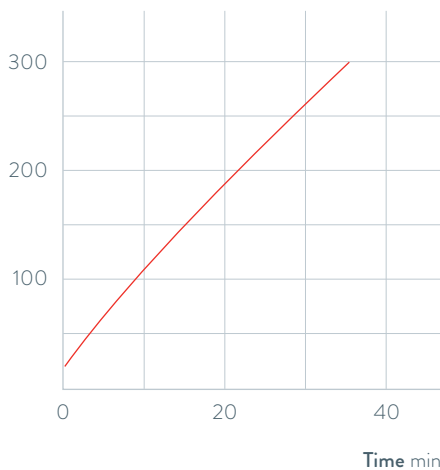

PJ 12/PJ 12 C
(up to 300 °C)
PJL 12/PJL 12 C
(up to 200 °C)

Important functions

- Stainless steel bath vessel (insulated, with handles and drain tap)
- Selectable Master control head with LED display or detachable Command operating unit with graphic LCD display
- LAUDA Vario Flex pump (pressure pump) with eight selectable output levels
- PowerAdapt system for optimally adapted max. heating output without influencing the mains power supply

Included accessories

Nipples, screw caps, bath cover

Further accessories

Calibration racks

All technical data and power supply variants can be found in the [Technical data](#) section.

More at www.lauda.de/1774



LAUDA Proline

For maximum temperatures up to 300 °C, the compact models of the LAUDA Proline PJ12 and PJ12 C can be used.



LAUDA Calibration thermostats

Device type overview

LAUDA ECO / Page 138

LAUDA Proline / Page 140

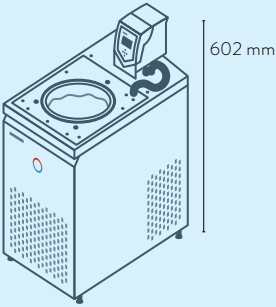

REJ 1225 G

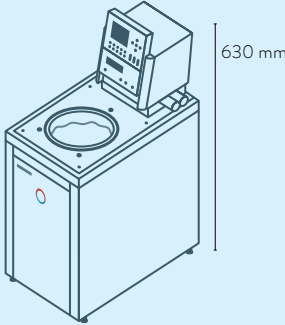

PJ 12 C
PJL 12 C

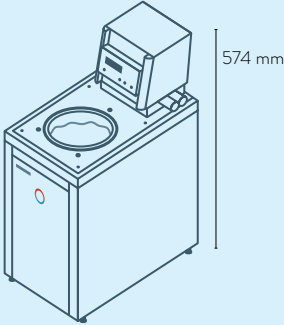

PJ 12
PJL 12

LAUDA Calibration thermostats

Interfaces

	Pt 100 (1)	Pt 100 (2)	USB	Ethernet	RS 232 / 485	Analog	Namur contact	Sub-D contact	Profibus	EtherCat M8	EtherCat RJ 45	Malfunction contact	Number of module slots, large	Number of module slots, small
LAUDA ECO REJ 1225 G / Page 138	Z	-	S	Z	Z	Z	Z	-	Z	Z	Z	Z	1	1
LAUDA Proline Master / Page 140	S	-	-	Z	Z	Z	Z	Z	Z	Z	Z	-	2	-
LAUDA Proline Command / Page 140	S	-	-	Z	S	Z	Z	Z	Z	Z	Z	-	2	-

S = Series standard

Z = Available as an accessory



LRZ 912
Analog module



LRZ 913
RS 232/485
interface



LRZ 914
Contact module with single input
and single output (NAMUR)



LRZ 915
Contact module with
3 inputs and 3 outputs



LRZ 917
Profibus module



LRZ 918
Pt100/Li bus module,
small cover



LRZ 921
Ethernet module

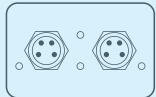

LRZ 922
EtherCAT module
with M8 connection

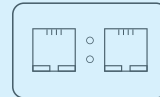

LRZ 923
EtherCAT module
with RJ45 connection



LRZ 925
External Pt100/LiBus-
module, large cover

LAUDA Calibration thermostats

Technical data according to DIN 12876 standard

Device type	Working temperature range °C	Operating temperature range °C	Temperature stability ±K	Safety fittings	Heater power max. kW	Cooling output kW					Pump type	Pump pressure max. bar	Pump flow max. pressure L./min	Pump connection thread mm
						20 °C	10 °C	0 °C	-10 °C	-20 °C				

LAUDA ECO / Page 138

REJ 1225 G	-25 ... 200	-25 ... 200	0.02	III, FL	2.6	0.30 ¹	-	0.24 ¹	-	0.09 ¹	V	0.6	22.0	M16 × 1
------------	-------------	-------------	------	---------	-----	-------------------	---	-------------------	---	-------------------	---	-----	------	---------

LAUDA Proline / Page 140

PJ 12	30 ... 300	0 ... 300	0.01	III, FL	3.6	-	-	-	-	-	V	0.8	25.0	M16 × 1
PJ 12 C	30 ... 300	0 ... 300	0.01	III, FL	3.6	-	-	-	-	-	V	0.8	25.0	M16 × 1
PJL 12	30 ... 200	-40 ... 200	0.01	III, FL	3.6	-	-	-	-	-	V	0.8	25.0	M16 × 1
PJL 12 C	30 ... 200	-40 ... 200	0.01	III, FL	3.6	-	-	-	-	-	V	0.8	25.0	M16 × 1

LAUDA Calibration thermostats

Power supply variants

Device type	Power supply V; Hz	Heater power max. kW	Loading max. kW	Plug code*	Cat. No.	Device type	Power supply V; Hz	Heater power max. kW	Loading max. kW	Plug code*	Cat. No.
-------------	--------------------	----------------------	-----------------	------------	----------	-------------	--------------------	----------------------	-----------------	------------	----------

LAUDA ECO / Page 138

REJ 1225 G	100 V; 50/60 Hz	1.0	1.3	14	L002851	REJ 1225 G	220 V; 60 Hz	2.4	2.7	3	L002852
REJ 1225 G	115 V; 60 Hz	1.3	1.4	14	L002849						

LAUDA Proline / Page 140

PJ 12	100 V; 50/60 Hz	1.3	1.5	4	L001947	PJL 12	100 V; 50/60 Hz	1.3	1.5	4	L001949
PJ 12	115 V; 60 Hz	1.7	1.9	4	L001937	PJL 12	115 V; 60 Hz	1.7	1.9	4	L001939
PJ 12	200 V; 50/60 Hz	2.7	2.9	3	L001951	PJL 12	200 V; 50/60 Hz	2.7	2.9	3	L001953
PJ 12	208-220 V; 60 Hz	3.3	3.5	3	L001943	PJL 12	208-220 V; 60 Hz	3.3	3.5	3	L001945
PJ 12 C	100 V; 50/60 Hz	1.3	1.5	4	L001948	PJL 12 C	100 V; 50/60 Hz	1.3	1.5	4	L001950
PJ 12 C	115 V; 60 Hz	1.7	1.9	4	L001938	PJL 12 C	115 V; 60 Hz	1.7	1.9	4	L001940
PJ 12 C	200 V; 50/60 Hz	2.7	2.9	3	L001952	PJL 12 C	200 V; 50/60 Hz	2.7	2.9	3	L001954
PJ 12 C	208-220 V; 60 Hz	3.3	3.5	3	L001944	PJL 12 C	208-220 V; 60 Hz	3.3	3.5	3	L001946

¹Pump output step 3

Nipples \varnothing_e	Bath volume min. L	Bath volume max. L	Bath opening \varnothing mm	Bath depth mm	Usable depth mm	Height top of bath mm	Dimensions (W x D x H) mm	Weight kg	Power supply V; Hz	Loading max. kW	Cat. No.	Device type
13	9.3	12.0	150	200	180	443	250×435×624	30.4	230 V; 50 Hz	2.9	L002848	REJ 1225 G
13	8.5	13.5	120	320	300	374	220×360×574	17.0	230 V; 50/60 Hz	3.7	L001923	PJ 12
13	8.5	13.5	120	320	300	374	220×360×630	17.0	230 V; 50/60 Hz	3.7	L001924	PJ 12 C
13	8.5	13.5	120	320	300	374	220×360×574	17.0	230 V; 50/60 Hz	3.7	L001925	PJL 12
13	8.5	13.5	120	320	300	374	220×360×630	17.0	230 V; 50/60 Hz	3.7	L001926	PJL 12 C

LAUDA Heat transfer liquids

For safe and reliable operation of your thermostats

Highly accurate temperature control at extreme temperatures, reliability and long-term operational stability for a long service life of the thermostats.

The right choice of heat transfer liquid is of critical importance for the safe and reliable operation of thermostats, circulation chillers or water baths. Thanks to our many decades of experience, we are able to offer optimum heat transfer liquids for LAUDA thermostats and other brands. Prices of heat transfer liquids can be found in our price list, which we will gladly send you on request.

Designation	Open / half-open systems °C						Closed systems with cold oil overlay (Integral XT) °C						Cat. No. 51/101/201
	-100 °C	-50 °C	0 °C	100 °C	200 °C	300 °C	-100 °C	-50 °C	0 °C	100 °C	200 °C	300 °C	
Aqua 90			5 °C		90 °C								LZB 120/LZB 220/LZB 320
Kryo 95 Silicone oil	-95 °C				60 °C		-95 °C					160 °C	LZB 130/LZB 230/LZB 330
Kryo 70 Silicone oil							-70 °C					220 °C	LZB 127/LZB 227/LZB 327
Kryo 65							-65 °C					140 °C	LZB 118/LZB 218/LZB 318
Kryo 60 Silicone oil		-60 °C			60 °C								LZB 102/LZB 202/LZB 302
Kryo 51 Silicone oil		-50 °C											LZB 121/LZB 221/LZB 321
Kryo 30			-30 °C						-30 °C			90 °C	LZB 109/LZB 209/LZB 309
Kryo 20 Silicone oil			-20 °C										LZB 116/LZB 216/LZB 316
Therm 160				60 °C									LZB 106/LZB 206/LZB 306
Therm 180 Silicone oil			0 °C										LZB 114/LZB 214/LZB 314
Therm 250 Silicone oil				50 °C									LZB 122/LZB 222/LZB 322
Ultra 350				30 °C					30 °C				LZB 107/LZB 207/LZB 307

Request the comprehensive LAUDA heat transfer liquid brochure at info@lauda.de

More at www.lauda.de/1782



LAUDA Accessories

Individual solutions, down to the finest detail

Optimized for your requirements

Operating constant temperature equipment often requires the use of vital accessory components. Only by using the right sampling frames, connecting parts, varied tubing connectors, distributors or interface modules, can applications be smoothly implemented.

LAUDA's comprehensive range of accessories offers you the ideal accompaniment to your complete solution, proven many times over, all from a single source.

Cooling of heating thermostats – Cooling coil sets, solenoid valvecooling water regulation

Level control – automatic filling device, Variocool flow control instrument

Connecting plugs, connecting cables

Bath covers – Stainless steel bath covers, bath cover sets, stainless steel gable covers

Racks, platforms, lifting platforms – Polycarbonate/stainless steel hanging racks up to 100 °C, test tube in polypropylene (up to 95 °C)/stainless steel (up to 150 °C), inserts for calibrating thermostats, lifting platforms, accessories for notch bending test/pour point determination

Hoses – Polymer hoses (insulated/uninsulated), reinforced EPDM hoses, insulating hoses for subsequent insulation, EPDM cooling water hoses, stainless steel hose clips, metal hoses with simple heat/cold insulation/for heat and cold/with multi-layered insulation

Adapters – Pump connector sets, hose connectors, quick couplings for cooling water connection, distributors, Integral XT bypass, ball cocks, screw caps, graphite seals

Additional pumps – Proline Kryomats (ex-works only), booster pump

Interface modules, remote controls – Interfaces

Temperature probes – Platinum resistance thermometers, connecting plugs, connecting cables, compression fittings

Other accessories – Backlight for viscothermostats, bath edge and window heating (ex-works only), castor base with castors /castor sets, Through-flow control unit for Integral XT

Request the comprehensive LAUDA accessories brochure at info@lauda.de

More at www.lauda.de/1784



LAUDA Accessories

LAUDA components offer you the fitting complement to your application – from very small to very large. Therefore you can easily personalize your application and meet every requirement – in the usual LAUDA quality.

Power plugs

Overview

Image	Plug code	Description	Image	Plug code	Description	Image	Plug code	Description
	2	CEE7/7 angled (EU, Schuko)		3	NEMA 6-20P (USA)		4	NEMA 5-20P (USA)
	5	GB2099 (CN)		6	BS1363 angled (UK)		7	IEC 60309, (blue), Caravan
	8	SEV 1011, SEV 5934/2 (CH, T23)		9	AS/NSZ 3112 (AUS)		10	NBR 14136 (BR)
	14	NEMA 5-15P (USA)		17	CEE7/7 straight (EU, Schuko)		21	IEC 60309, 5-pin, CEE, red, 16 A
	22	IEC 60309, 5-pin, CEE, red, 32 A		23	IEC 60309, 5-pol, CEE, rot, 63 A		25	NEMA 5-15P (Japan)
	26	SEV 1011, SEV 5934/2 (CH, T12)		31	Mains cable without plug (HAR), Harmonized cable (DIN VDE 0281/DIN VDE 0282/DIN VDE 0292)		32	Mains cable without plug (AWG), American Wire Gauge, abbreviation AWG
	33	NEMA L16-30P twist lock; 30 A 480 V 30 A, 3L+N+PE		34	NEMA L16-20P twist lock; 20 A 480 V 20 A, 3L+N+PE		35	AS/NSZ 3112, SAA/3 (AUS) Australia, 250 V; 10 A
	36	NEMA 6-15P (USA) USA, 250 V; 15 A		37	NBR 14136, BR/3 (BR) Brazil, 250 V; 10 A			

